



# PCT1200

Precision current transducer 1200 A

## User Manual

©Copyright 2022

ZES ZIMMER Electronic Systems GmbH

Pfeiffstraße 12

61440 Oberursel (Taunus), Germany

phone +49 (0)6171 88832-0

fax +49 (0)6171 88832-28

e-mail: [info@zes.com](mailto:info@zes.com)

Internet: <http://www.zes.com>

No part of this document may be reproduced, in any form or by any means, without the permission in writing from ZES ZIMMER Electronic Systems GmbH.

Observe copyright notice according to DIN ISO 16016!

We reserve the right to implement technical changes at any time, particularly where these changes will improve the performance of the product.

# Manufacturer Declaration

ZES ZIMMER Electronic Systems GmbH certifies herewith that the device to which this declaration belongs to is in compliance with all specifications contained in the delivered user manual. It has left the factory in mechanically and electrically safe condition.

The measuring instrument, tools and standards used in production, adjustment and calibration are calibrated according to ISO 9000 (traceable to national standards) and correspond to the standard of precision required to maintain the specified accuracies.

**ZES ZIMMER**

Pfeiffstraße 12  
D-61440 Oberursel  
Germany  
[www.zes.com](http://www.zes.com)

## 1 Used symbols

This manual describes and explains symbols which are found here and displayed on the equipment. Observation of these warning signs is required for safe operation.



### Electric shock

This symbol indicates danger of injury or death from electric shock due to dangerous voltages. *Do not touch. Use extreme caution.*

AC voltages over 33 V RMS, 46.7 V peak and DC voltages over 70 V are deemed to be hazardous live according to IEC 61010 resp. EN 61010. There is a danger of electric shock. This can cause death or injury to body or health. Furthermore, there is a risk of material damages.



### High temperature

This symbol indicates a high temperature. There is a burn and fire hazard. There is a danger of fire or injury to body or health due to hot surfaces or material. Furthermore, there can be material damages to other objects due to contact or close proximity. If a burn or fire does occur, there can be further damages which can cause death or injury to body or health.



### Caution

This symbol indicates the risk of damages to persons or material. Also if material damages occur, there can be further damages which can cause death or injury to body or health.

This symbol on the equipment indicates that this user manual is to be consulted for instruction or further information provided in order for safe operation.



### Information

This symbol indicates facts or information regarding the equipment which should be observed for easy and accurate operation.



### Protective conductor terminal

This symbol indicates the terminal for the protective conductor. See also CONNECTION TO POWER SUPPLY AND PROTECTIVE CONDUCTOR [2.1→6].

### References/links

[→4]

References to tables, figures, listings, etc. consist of their identifier followed by the book symbol and the page number.

USED SYMBOLS

[1→4]

References to chapters, sections, and subsections consist of the heading of the section and the sectional number followed by the book symbol and the page number.

In the PDF version of this document, one can click on any of these reference elements to jump to the reference.

## 2 Safety recommendations

This equipment was designed according to IEC 61010 and EN 61010 and has left the factory in a mechanically and electrically safe condition. To maintain safe operation, the user must follow the instructions and warnings contained in this manual. The equipment must only be used for the purposes described in this manual.

If damage to the equipment is suspected, it must be removed from operation to prevent possible further damages or injury. In addition the required repair work must be carried out by a trained technician at a suitable repair facility.











Until shown to be otherwise, the equipment must be considered unsafe to operate if

- there is visual evidence of physical damage,
- it fails to operate correctly,
- the equipment has been heavily overloaded due to high currents (short circuit or something similar),

- the equipment has been heavily overloaded due to high voltages,
- the equipment has been operated with supply voltage outside specifications,
- there are loose parts inside the equipment,
- long term storage has taken place in conditions outside the stated specifications for safe storage,
- condensation is present, or
- rough transport has occurred.

The intended use of this equipment (within the limitations stated in the technical data) is to measure electrical current and/or voltage.

When handling electricity and/or an electrical apparatus, be sure to observe all safety rules. These rules include, but are not limited to, the following:

- Opening the equipment exposes components which are under high voltage. *This is only permitted to trained personnel. User risks injury by removing cover and may void any manufacturer's warranty.* All voltage sources must be disconnected from the equipment before any equipment covers are removed. Only suitably qualified personnel are permitted such access for the purpose of calibration, service, repair or changing of components.  
If the equipment has been opened, a high voltage test and a test of the protective conductor are necessary according EN 61010 following the closing of the equipment for safety purposes prior to use. 
- Fuses may only be replaced with the correctly rated and recommended types as written in this manual. Reading the rated values from the fuse to be replaced is not permitted. The use of repaired, short-circuited or insufficient fuses is not permitted. 
- The environmental conditions (see GENERAL ENVIRONMENTAL CONDITIONS [3→8]) must be observed to ensure safe operation of the equipment.  
Use in any type of wet or explosive environment or in presence of flammable gases or liquids is especially prohibited. 
- The equipment and accessories (such as wires and clips) must be checked before each use. Defective parts must be replaced. 
- Ventilation openings must be kept clear (see GENERAL ENVIRONMENTAL CONDITIONS [3→8]) to guarantee the required air flow and to prevent overheating of the equipment. In the same way, the air filter at the air inlets must be clean to permit sufficient air flow. Do not operate the equipment without air filter or the filter holder as injury may result.  
Especially take care that the equipment is not placed above sheets of paper which could get sucked into the ventilation openings at the bottom of the equipment!  
When mounting the equipment into a rack, make sure that the slide rails do not cover any ventilation openings. 
- The equipment must not be used in a medical environment nor in any other environment that may have a potential effect on life or health. 
- Impacts or rough handling may damage the equipment. Do not place heavy objects on the equipment. 
- If the weight of the equipment is too heavy to be carried by one person, carry the equipment with two persons and/or use an appropriate tool. In all cases, use the handles and grips of the equipment to lift and carry it safely. 
- The equipment is *not* designed to detect hazards or similar! A wrong reading (e.g. by choosing a wrong filter or range) could give you the wrong impression of a safe state. Use appropriate tools (e.g. a voltage detector) instead of this equipment to detect dangerous situations. 
- Be careful when connecting external equipment like an external keyboard or mouse to an instrument. They might not be designed to operate in the same EMC environment as the instrument and therefore they could be disturbed. This could lead to unwanted operation of the instrument like changing ranges or something similar. 



- When connecting the instrument watch the order of connections: First connect it to the protective conductor and the power supply (see CONNECTION TO POWER SUPPLY AND PROTECTIVE CONDUCTOR [2.1→6]), then connect it to the measurement circuit (see CONNECTION TO MEASUREMENT CIRCUIT [2.2→6]). Then switch on the instrument and the equipment, and finally, after double checking the wiring, switch on the measurement circuit.



- This equipment was designed according to IEC 61010 and EN 61010 which are general safety standards for equipment for measurement, control and laboratory use. In a concrete application or environment further safety standards might be applicable and have to be regarded in addition.

## 2.1 Connection to power supply and protective conductor



- Before connecting the mains cable to the power supply, confirm that the mains supply voltage corresponds to the voltage printed on the model's identification plate. If a voltage selector switch exists, it must be set appropriately. A suitable power source has to be used to operate the equipment/instrument.



- The mains plug may only be inserted into a mains power supply socket with protective earth contact. This protection must not be disabled by the usage of plugs, cables or extension cords without protective earth.

The mains plug must be inserted into the mains socket *before* any other connections are made to the equipment/instrument. Any kind of interruption of the protective earth, inside or outside the equipment/instrument, or disconnecting the protective earth connector can result in an unsafe condition of the equipment/instrument and is not allowed. The usage of cables, plugs, sockets or adapters with only two poles, prongs or connectors is not allowed.

The *additional* protective conductor terminal of the equipment/instrument chassis must be used for the case where an earth current in excess of 10 A might result accidentally from the circuit under test.



*Such currents are too large for the earthing connection of the equipment/instrument's supply cord. In case of a single fault, the protective conductor might not be able to carry this current. If it would be interrupted, the case would no longer be protected against electric shock!*

In this case, connect the additional protective conductor terminal with an adequately rated cable to a suitable earthing point. The additional protective conductor terminal is limited to currents up to 32 A.

If reliable earthing cannot be realized, the connections between the circuit under test and the equipment/instrument must be fused appropriately.

The earth terminal on the equipment/instrument must not be used as the only earth connection for the equipment/instrument nor must the circuit under test nor any other equipment/instrument be earthed by this terminal. The additional protective conductor is marked with following symbol:



## 2.2 Connection to measurement circuit



- Remove all energy sources from the measurement circuit before making any connections between this circuit and the analyzer. Do not connect or disconnect any cables while they are carrying voltage relative to earth.



- Use only measurement cables with safety connectors and sufficient cross section. Be sure that the cables have a sufficient voltage and current rating and are usable for the desired overvoltage and measurement category.

*Cables not having safety but standard connectors might have insufficient clearance and creepage distances, even if they are plugged into the socket. So there is always a risk of an electric shock.*



Use only colored cables which match to the color of the jack to help prevent a wrong connection.

When connecting the measurement circuit, take special care not to connect the voltage wires to the current input of the equipment/instrument. When switching the measurement circuit on, this would result in a short circuit which risks damage to the analyzer and to the user!

*Such short circuits can be very dangerous, as currents of several thousand amperes might flow during the short circuit!*



For the connection of the *voltage* measurement circuit to the equipment/instrument use *only* cables with suitable fuses, like those delivered together with the equipment/instrument.

*The fuses in the voltage measurement cables will interrupt the current flow in case that these cables are accidentally inserted into the low ohmic current measurement jacks. Therefore short circuiting of a high power source (e.g. the output of an energy distribution transformer) will not cause any hazard.*



The yellow and black voltage cables have each an implemented fuse. Before and after each measurement: Check the fuse! To replace this fuse, remove the cable on both sides from all circuits to make it free of dangerous voltages. Unscrew the fuse holder. Replace the fuse only with following type:

6.3x32 mm, FF 500 mA, 1000 V, AC+DC, 30 kA breaking capacity

Screw the fuse holder together again.

- When connecting to high power measurement circuits (e.g. the output of an energy distribution transformer), massive damage could occur when mismatching cables, short-circuiting the measurement circuit, or using the current jacks of the equipment/instrument instead of the voltage jacks and similar. So it is recommended to use appropriate fuses in *all* measurement cables. When selecting a fuse, ensure that at least the following properties are met:



- The usual measuring current must flow without interruption (rated current of the fuse)
- The short circuit current of the measurement circuit must be interrupted safely (breaking capacity of the fuse)
- The maximum voltage of the measurement circuit must be interrupted safely (rated voltage of the fuse)
- The fuse must be suitable for the type of current: AC, DC or both (breaking capacity of the fuse)
- The fuse must be fast enough to protect the cables and the equipment/instrument

- The maximum voltages between the voltage jacks may not exceed the technical specifications.
- The maximum currents at the current jacks may not exceed the technical specifications.
- The maximum voltages of the jacks against earth may not exceed the technical specifications.
- External current sensors or transformers must be connected to wires and jacks which have a ten times higher overload capability, only. If the cables or jacks are not sufficient they could be interrupted in case of overload! For the same reason it is *not* allowed to use fuses in this current measurement wires.



Before using jacks, test if they have a low impedance current path to prevent high voltages at the output of the external device.

*In general, it is dangerous to interrupt the secondary side of a current transformer as there might appear very high voltages which could lead to electric shock.*





- Cables from/to external sensors are usually designed to operate with low voltages (e.g. <math><15\text{ V}</math>). When using these in an environment with a high voltage circuit, use caution as further isolation might be necessary. For the operation itself the isolation is sufficient, but if these cables touch a bare conductor with dangerous voltages this can cause an unsafe condition! In such cases, further isolation might be necessary.

For example, the secondary cables of a current clamp have a very low voltage, but they could touch the current bar which has a dangerous voltage against earth.



- Especially when establishing external connections, special care must be taken to prevent electrostatic discharge.
- Different sensors might require different connection cables to the instrument. When changing a sensor, please ensure that a correct cable is used. Usually the cable is dedicated to a sensor.
- Keep away from energized measurement circuits to prevent electric shock. When performing measurements on installations or circuits, please observe all safety regulations and guidelines. In particular, only suitable measurement accessories should be used. Only suitably qualified personnel are permitted to work with energized measurement circuits.
- When you put the equipment/instrument out of operation, all external cables shall be removed. Special care has to be taken when disconnecting current sensors. Before interrupting their secondary current, the primary current has to be switched off. After disconnecting, the secondary side of the current sensors has to be short-circuited to prevent dangerous voltages.

### 3 General environmental conditions

The general environmental conditions, *except limited or extended by a specific sensor*, are:

- Indoor use only
- Altitude up to 2000 m
- Temperature  $+5^{\circ}\text{C}$  ...  $+40^{\circ}\text{C}$
- Maximum relative humidity 80 % for temperatures up to  $+31^{\circ}\text{C}$  decreasing linearly to 50 % relative humidity at  $+40^{\circ}\text{C}$
- Mains supply voltage fluctuations up to  $\pm 10\%$  of the nominal voltage
- Transient overvoltages up to the levels of overvoltage category II, i.e. to be supplied from a power outlet of the building wiring
- Temporary overvoltages occurring on the mains supply
- Pollution degree 2, i.e. only non-conductive pollution occurs except that occasionally a temporary conductivity caused by condensation is expected

### 4 Technical assistance

For technical assistance you can contact the supplier of the equipment/instrument or the manufacturer:

ZES ZIMMER Electronic Systems GmbH  
Pfeiffstraße 12  
61440 Oberursel, Germany  
Phone: +49 (0)6171/88832-0  
Fax: +49 (0)6171/88832-28  
Email: [info@zes.com](mailto:info@zes.com)  
URL: <http://www.zes.com>



## 5 Precision current transducer 1200 A (PCT1200)

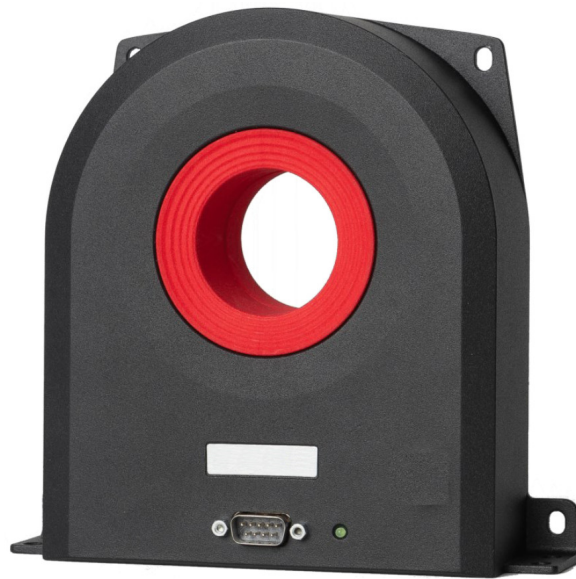

Figure 1: PCT1200

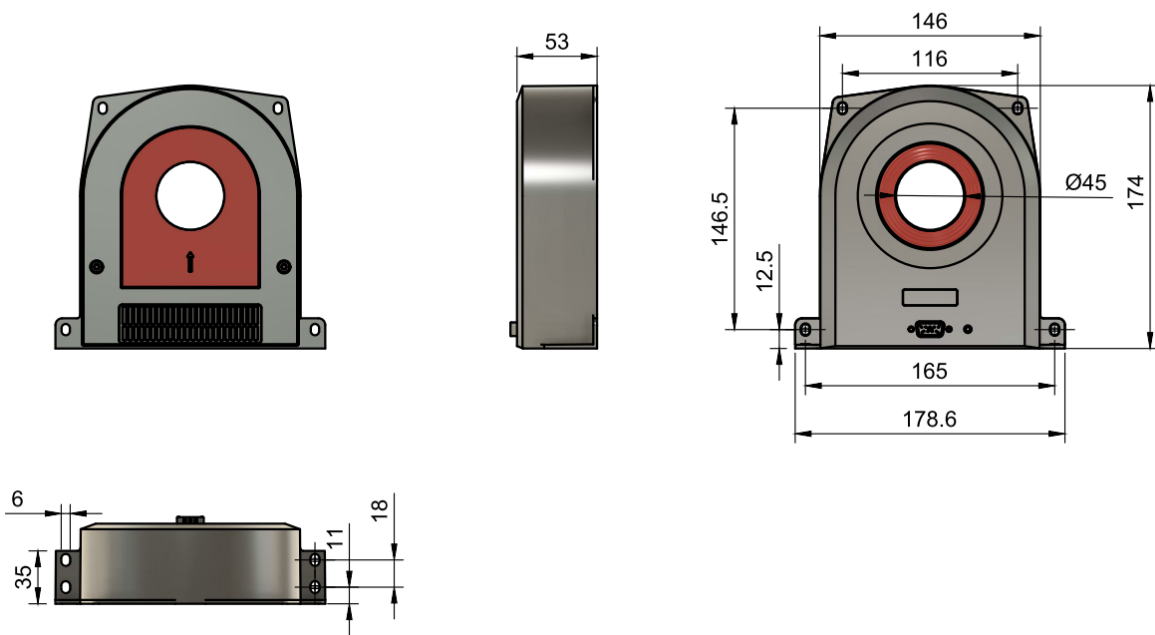

Figure 2: PCT1200 mechanical dimensions, all dimensions in mm, positive current direction is identified by an arrow on the transducer body

A contact free, closed loop, flux gate based current measurement sensor, developed to offer extreme linearity and full industrial temperature range. The sensor has an aluminium body for shielding against EMI.

## 5.1 Safety warnings



- Always connect the sensor first to the meter and afterwards to the device under test.
- Attention: when using busbar without insulation, regard DSUB cable insulation or avoid contact!
- Please refer to chapter SAFETY RECOMMENDATIONS [2→4]!

## 5.2 Standards and Directives



This product meets the following EU standards for health, safety, and environmental protection:

Safety	EN 61010-1:2010
EMC	EN 61326-1



This product shall be disposed of or recovered in compliance with directive 2012/19/EU. If you wish to discard this product, please contact your dealer or supplier for further information. This symbol is only valid in the European Union (EU). If you wish to discard this product outside the EU, please contact your local authorities or dealer and ask for the correct method of disposal.



This product meets the Directive 2011/65/EU of the European Parliament and of the Council of 8 June 2011 on the restriction of the use of certain hazardous substances in electrical and electronic equipment.

## 5.3 Specifications

Nominal input current rms	1200 A
Maximum input current rms (depends on power meter and connection cable)	1500 A
Maximum input current peak (depends on power meter and connection cable)	1800 A
Transformation ratio	1500:1
Maximum input overload	5000 A, 100 ms, normal operation after overload
Bandwidth (-3 dB, small signal)	400 kHz
Offset temperature coefficient	±0.1 ppm/K (refers to Maximum input current peak)
Burden	0 ... 3 Ω (if supplied with PCTSIU4 / PCTSIU4-1U and a PCT-DSUB connection cable up to 10 m length: the burden is defined as the resistance from the secondary output connectors of PCTSIU4 to the instrument)
Rated isolation voltage according to IEC 61010-1	600 V CAT II 300 V CAT III pollution degree 2
Rms voltage for AC isolation test, 50/60 Hz, 1 min between primary and (secondary and shield) between secondary and shield	14.4 kV 200 V
Impulse withstand voltage	26.3 kV
Creepage distance	12 mm
Comparative Tracking Index	CTI 600
Operating temperature	-40 °C ... +85 °C
Storage temperature	-40 °C ... +85 °C
Weight	1.5 kg

Supply	$\pm(15\text{ V}\pm 0.75\text{ V})$ 1.33 A
--------	---

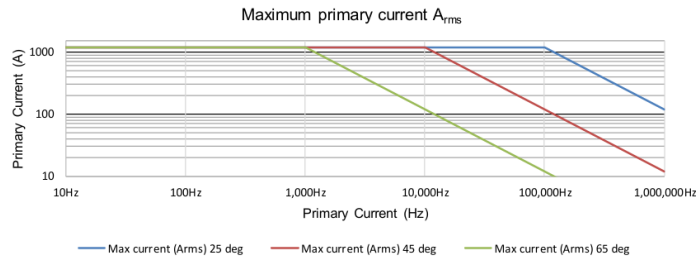

Figure 3: PCT1200 temperature derating of input current vs. frequency and temperature

#### 5.4 Accuracy specification

The accuracy specification is based on: sinusoidal current, ambient temperature  $+23\pm 3^\circ\text{C}$ , calibration interval of 1 year, primary conductor in the middle of the transducer.

Frequency	Accuracy specification for amplitude in % of nominal input current rms	Accuracy specification for phase in $^\circ$
DC ... 10 Hz	$\pm 0.0015\%$	$\pm 0.01^\circ$
10 Hz ... 3 kHz	$\pm 0.01\%$	$\pm 0.01^\circ$
3 kHz ... 50 kHz	$\pm 1\%$	$\pm 0.5^\circ$
50 kHz ... 300 kHz	$\pm 20\%$	$\pm 10^\circ$

See specification of the LMG connection cable for the LMG measuring ranges and to calculate the accuracy of the complete system.

#### 5.5 DSUB9 connector pin assignment of PCT1200

DSUB9 pin	
1	output current return
2	nc
3	status
4	GND
5	-supply
6	output current
7	nc
8	status
9	+supply

Status pin properties: Open collector output with forward direction pin 8 to pin 3. Maximum forward current: 10 mA. Maximum forward voltage: 60 V. Maximum reverse voltage: 5 V.

#### 5.6 Installation

Grounding the transducer head is strictly recommended! Even if there is no requirement for safety ground on the product, for safety reasons the transducer head PCT1200 is strictly recommended to be connected to earth ground! If in case of damage in the installation a bare conductor connects the aluminium housing this will prevent the transducer head and the LMG connection cable to be energised. Connect the earth wire to the transducer head PCT1200 using a ring terminal and a toothed locked washer designed for the maximum short circuit current of the installation, fastened to one of



the 6.5 mm mounting holes. Grounding of the transducer head PCT1200 is also recommended to lead away capacitive coupled distortion.

For LMG600 use the connection cable 'PCT1200-K-L6' and optionally the extension cable 'LMG-Z-SVTxx' or 'LMG-Z-DV'. For other instruments use the supply unit PCTSIU4 together with the connection cable PCT-DSUB between PCT1200 and PCTSIU4.

Also if bare conductors can be used up to the above isolation voltages, it is strictly recommended to use insulated conductors only. By this is prevented, that the housing of a transducer might short circuit two conductors. Further more there are no problems when the secondary cable touches a primary conductor.

Use LMG connection cable and PCT with corresponding serial numbers!

Do not power up the device before all cables are connected!

### 5.7 System power-on sequence



Do not allow primary current without supply of the sensors! Even though the sensor is protected by an internal sensor protection circuit, the sensor will never start its normal operation with primary current applied before proper supplied.

1. ensure proper connection of the sensor with the power meter LMG
2. turn on the power meter LMG to ensure the supply of the sensor
3. wait until the normal operation status is signaled by the green LED
4. now start the measurements

### 5.8 Internal sensor protection circuit

Both AC and DC primary current can be applied up to 100 % of nominal current under following conditions:

- Sensor is unpowered and secondary circuit is open
- Sensor is unpowered and secondary circuit is closed
- Sensor is powered and secondary circuit is open
- Sensor is powered and secondary circuit is interrupted during measurement

Note that the sensor core will be magnetized in all four cases, leading to a small change in output offset current (less than 10 ppm).

### 5.9 Connection of the sensor PCT1200 with LMG600

Use the connection cable 'PCT1200-K-L6' and L60-X-ADSE, supply via LMG600.

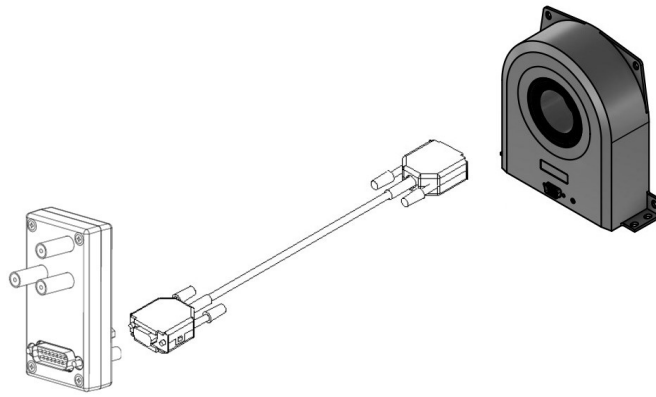

Figure 4: PCT1200 and PCT1200-K-L6 and L60-X-ADSE

The cable 'PCT1200-K-L6' is used to connect the precision current transducer PCT1200 to the power meter LMG600. Internal electronic of the connector to the LMG600 contains the adjustment data of the PCT1200 head as well as measuring ranges, sensor name and serial number. This data is read out of the sensor automatically.

### 5.9.1 Supply current limitations

Due to the supply current limitations of the LMG640/641/670/671 up to 3 PCT1200 Sensors can be supplied by the LMG640/641/670/671. For 4 or more PCT1200 Sensors, please use the external supply unit PCTSIU4 or PCTSIU4-1U.

Please regard the maximum supply current capability of the LMG, when connecting one or more PCT1200 together with other PCT to the same LMG!

Power meter	Supply current capability	Supply capability
LMG670/671	$\pm 5$ A	up to 3 PCT1200
LMG640/641	$\pm 5$ A	up to 3 PCT1200
LMG610	$\pm 1.33$ A	1 PCT1200

### 5.9.2 PCT1200-K-L6

Insulation	No safety insulation, working voltage max. 50 V
Connectors	DSUB9 female / DSUB15 male, knurled screw or locking screw
Operating temperature	+5 °C ... +40 °C
Cable length	2.5 m

### 5.9.3 Connection

- switch all power off
- plug the connector labeled 'Connect to PCT1200 with SN xxx' to the sensor with SN xxx
- plug the connector labeled 'PCT1200-K-L6' to the adapter L60-X-ADSE mounted on the LMG600 current channel
- now switch on the power and begin your measurements - the power of the equipment under test should be switched on at least!

### 5.9.4 Measuring ranges of LMG600 with PCT1200 and PCT1200-K-L6

Power measurement channel L60-CH-A, L60-CH-B and L60-CH-C:

Nominal range / A	7.5	15	30	60	120	225	450	900	1200
Max. TRMS value / A	8.25	16.5	33	66	132	247.5	495	990	1500
Max. peak value / A	21	42	84	168	336	703.5	1407	1800	1800
Range peak value for accuracy calculation / A	21	42	84	168	336	703.5	1407	2812.5	5625

Power measurement channel L60-CH-S:

Nominal range AC / A	7.5	15	30	60	120	225	450	900
Nominal range DC / A	15	30	60	120	225	450	900	1500
Max. TRMS value / A	16.5	31.5	63	126	240	480	960	1500
Max. peak value / A	21	42	84	168	336	703.5	1407	1800
Range peak value for accuracy calculation / A	21	42	84	168	336	703.5	1407	2812.5

### 5.9.5 Accuracy

Use PCT1200 and LMG600 specifications to calculate the accuracy of the complete system. Since the 'max. peak value' is limited by the LMG ranges as well as the current sensor, please use 'range peak value for accuracy calculation' to determine the LMG600 accuracy.

Due to the internal connection of PCT1200-K-L6 with the direct current input I\* and I, please use the LMG600 accuracy specifications for the 5 mA ... 5 A ranges.

### 5.10 Connection of the sensor PCT1200 with PCTSIU4

For the use of PCT1200 with other instruments with current input and supply via PCTSIU4. Connect PCT1200 with PCT-DSUB to PCTSIU4. Secondary current output at PCTSIU4 via two 4mm connectors.

### 5.11 Connection of the sensor PCT1200 with LMG95, LMG450 or LMG500

Use PCTSIU4 for the supply of PCT1200 and the current output at PCTSIU4 via two 4mm connectors to LMG95, LMG450 or LMG500.

### 5.12 Connection extension

To use the current sensor with a larger connection length between power meter and PCT connect a well shielded extension cable between the PCT (DSUB9f plug) and the PCT connection cable (DSUB9m plug) and screw both plugs together. This extension cable is available at ZES ZIMMER: 'LMG-Z-SVTxx' or 'LMG-Z-DV' in different lengths. Interference from strong electromagnetical disturbed environments may affect the measurement accuracy. This depends from the respective installation in the complete system and is out of responsibility of ZES ZIMMER.

