

Anritsu Advancing beyond

Field Master Pro™

High-Performance RF Spectrum Analyzer

MS2090A

9 kHz to 9/14/20/26.5/32/43.5/54 GHz



THE SKY'S

The Anritsu Field Master Pro M
performance handheld



FieldMaster Pro™ MS2090A

THE LIMIT



MS2090A. The world's highest
and spectrum analyzer.

No limits.

Delivering the highest levels of performance available in a handheld RF spectrum analyzer, the Field Master Pro MS2090A instrument gives field engineers and technicians unparalleled measurement accuracy previously reserved for only benchtop instruments.

No gaps.

Integrated and continuous frequency coverage from 9 kHz to 54 GHz provides the ability to view the RF spectrum and measure all transmissions in order to avoid interference.

No misses.

The built-in real-time spectrum analyzer (RTSA) provides the ultimate signal analysis and interference capture tool. RTSA spans up to 110 MHz (option dependent) and provides capabilities for cellular interference monitoring to full industrial, scientific, and medical (ISM) band signal analysis. Its unparalleled performance meets the latest 5G test challenges while maintaining support for a full range of wireless technologies in use today. The IQ capture and streaming options allow for analyzing signals in the greatest detail.

Field Master Pro MS2090A

OVERVIEW

The Anritsu Field Master Pro MS2090A high-performance handheld RF spectrum analyzer is the culmination of over 60 years of microwave test and measurement equipment development that leverages the very latest technologies to deliver performance and accuracy previously reserved for only benchtop instruments. With continuous frequency coverage from 9 kHz to 9/14/20/26.5/32/43.5/54 GHz, the Field Master Pro MS2090A is leading the way for next-generation test equipment designed to meet the unique needs of technologies used in 5G networks (millimeter-wave [mmWave] frequencies, active antenna systems, beamforming, and dynamic physical layer attributes) while maintaining support for the full range of requirements of today's wireless industries such as wireless service providers, broadcasting, regulatory authorities, aerospace/defense, satellite systems, and radar.

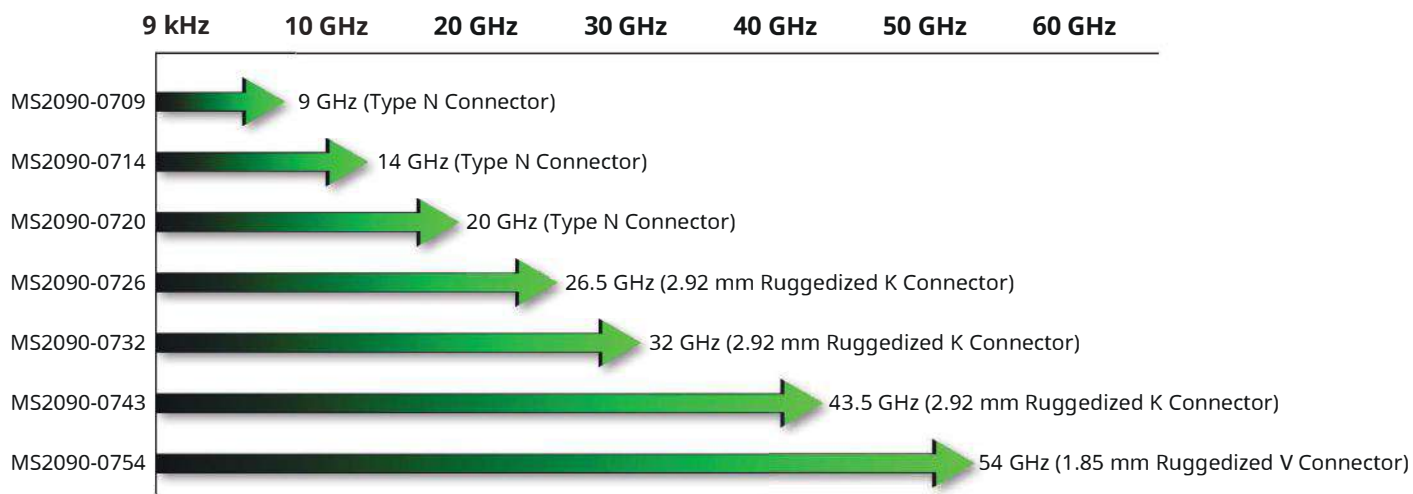

As RF technologies continue to become more ingrained in our daily lives, the RF spectrum is becoming more crowded at all frequencies. 5G radios are now being deployed at 28 GHz and 39 GHz in addition to the spectrum demands of sub-6 GHz cellular systems for mobile applications. The use of electronics in the automotive industry is growing rapidly as seen with sensors for autonomous driving becoming pervasive in today's vehicles. As we all continue to consume more data and expect faster access even in remote locations, point-to-point radio links are moving higher in frequency and expanding in bandwidth to support these demands. The ability to view the RF spectrum and measure the transmissions from all of these systems is critical in order to avoid interference and guarantee performance. The Field Master Pro MS2090A high-performance RF spectrum analyzer was developed to provide field service engineers and technicians with the unparalleled performance and functionality needed to meet the growing demands of these complex systems - all in a handheld, battery-powered instrument.

Field Master Pro MS2090A



Key RF Specifications

Parameter	Specification
Frequency range	9 kHz to 9/14/20/26.5/32/43.5/54 GHz
Analysis bandwidth	110 MHz
Demodulation	5GNR and LTE FDD/TDD RF and modulation quality measurements
TOI	+20 dBm
DANL (with pre amp)	-164 dBm
Amp range	DANL to +30 dBm
Phase noise @ 1 GHz	-110 dBc/Hz @ 100 kHz offset (typical)
RBW/VBW	1 Hz to 10 MHz
Input SWR	1.5
Amplitude accuracy	< 14 GHz ± 1.3 dB (± 0.5 dB typical)
RTSA bandwidth	22 MHz, 55 MHz, 110 MHz (option dependent)

Key Features

Feature	Specification
Display	10.1 inch, 1280 x 800 color touchscreen
Traces	6
Detectors	Peak, RMS/Average, Negative, Quasi Peak
Gated sweep	For time gated spectrum measurements
Markers	12, fully featured with table
Limit lines	Complex limit lines with Pass/Fail
IQ	Capture and streaming of IQ data
Trace record and playback	Record and replay spectrum traces to/from internal memory
GNSS	GPS, GLONASS, Galileo
Interfaces and connectivity	USB 3.0, USBTMC, Ethernet, 802.11b/g/a/n/ac
Battery life	>2 hours (function dependent)

Unmatched RF Performance

The Field Master Pro MS2090A device delivers the highest levels of RF performance available in a handheld, touchscreen spectrum analyzer. With a displayed average noise level (DANL) of -164 dBm and third-order intercept (TOI) of typically $+20$ dBm, measurements such as spectrum clearing, radio alignment, harmonic, and distortion are even more accurate than previously possible. For modulation measurements on digital systems, 110 MHz modulation bandwidth coupled with best-in-class phase noise performance maximizes measurement accuracy, while 0.5 dB typical amplitude accuracy provides confidence when testing transmitter power and spurious emissions.

Feature-Rich Device Enhances Usability

All Field Master Pro MS2090A models offer a comprehensive range of features that speed and simplify measurements.

- Built-in **RTSA** provides the ultimate signal analysis and interference capture tool. RTSA spans of 22, 55, or 110 MHz (option dependent) with $2.05 \mu\text{s}$ POI that provides capability for cellular interference monitoring to full ISM band signal analysis.
- **IQ capture and streaming options** enable comprehensive off-line processing of IQ data. With up to 110 MHz capture bandwidth and the option to utilize the 2 GB of internal memory or continuously stream over Ethernet, USB 3.0, or a high-speed digital interface, it is possible to post-process signals to hunt for and identify the most elusive signals.
- In addition to a **full span swept-tuned spectrum analyzer**, all versions include a **spectrogram display**. Spectrograms are a view of how the frequency content of a signal changes with time. It is especially useful when monitoring the RF spectrum for intermittent or interfering signals.
- **Integrated smart measurements** including channel power, occupied bandwidth (OBW), and adjacent channel power (ACPR) measurements simplify the analysis and characterization of common radio transmissions. Regulatory authorities typically specify limits for transmitters based on these measurements.
- **Up to 12 markers** can be placed on traces with a comprehensive marker table displaying all marker values. Marker counter and noise marker features further extend the utility of the instrument.
- **Complex limit lines of up to 40 segments** with pass/fail upper and lower limits simplify testing against international or in-house standards. The limit line envelope feature automates the setting of limits relative to existing signals and enables alarms to be set on detection of intermittent interferes, including save on event of limit fail.
- **Trace Record and Playback**. Record spectrum traces to internal memory and play back at user set speed to capture and view intermittent and transient signals.

Rugged Design for Field Use

With years of experience designing instruments for the field, Anritsu knows how durable and robust test equipment needs to be. From cell sites in the extreme cold of the Antarctic to satellite earth stations on desert mountain tops, test instruments need to be ready — whatever the conditions. The durable rubber over-mold covers a hardened steel frame to protect the instrument from the knocks and blows that happen when field technicians are on-site. All connectors are protected from damage by covers or protruding instrument bezels. The large 10.1 inch color touchscreen is protected by tempered soda lime glass designed to exceed the impact protection IK08 rating and standard, protecting it against 5 joules of impact (the equivalent to the impact of a 1.7 kg mass dropped from 300 mm above the impacted surface). A grab handle is located on the side and large D rings are mounted to attach the supplied shoulder strap when required.

High-Resolution Multi-Touch Screen and Modern User Interface Eases Usability

The Field Master Pro MS2090A spectrum analyzer features menus and a user interface developed to meet industry-standard guidelines for touchscreen instruments. Frequently used functions are immediately accessible and touching on-screen values opens up dialog boxes for rapid changes. Menus can be collapsed to maximize the trace display area or detailed trace settings can be displayed on the screen so that complex configurations are easily understood. Support for familiar, multi-touch gestures allows you to swipe and scan across the frequency range or pinch and zoom to quickly view signals of interest (SOI). A stylus stored in the carry handle facilitates the use of the screen even when wearing gloves or if you simply prefer a tool instead of your finger. The 1280 x 800 resolution screen offers excellent brightness with high-contrast color schemes. Switch between the standard color palate for normal use or a black and white high-contrast display for better visibility in direct sunlight.



Field Master Pro MS2090A Features a 10.1 Inch Multi-Touch Screen

APPLICATIONS

Interference Hunting and Spectrum Clearing

The value of RF spectrum allocations has grown rapidly as cellular and broadcast operators expand their networks. Spectrum usage is changing as older technologies, such as broadcast television or private mobile radio, are moved out of the sub-6 GHz bands and new technologies take their place. Many national regulatory authorities have auctioned and reallocated the spectrum, reassigning the frequency bands for exclusive access. In order to deploy new networks efficiently, the owners of the spectrum must clear the spectrum and validate that all legacy users have stopped all transmission. The Field Master Pro MS2090A coupled with Mobile Interference Hunting™ MX280007A software is ideal for wide area spectrum clearance.

To maintain the integrity of communications networks, interfering signals need to be detected and located rapidly. Interfering RF sources can be the result of illegal broadcasts, faulty transmitters or noise generating industrial equipment. Field Master Pro offers a comprehensive range of features to support RF technicians identify and locate sources of RF interference:

- Pinpoint and demodulate interfering signals using a directional antenna with Interference Finder Option 24 providing fast audio response to changes in signal power plus AM/FM audio demodulation
- Trace record and playback to monitor and capture signals over a period of time
- Interfaces with the Mobile Interference Hunter software MX280007A for a fully integrated solution to locate sources of interference on a digital map
- Up to 6 traces can be individually configured to display max or min hold
- Spectrogram displays facilitate the long-term monitoring of the spectrum so that intermittent signals are captured and stored
- Power spectral density mode in the RTSA enables the identification of interfering signals that are located at the same frequency as the wanted signal but lower in power

Selecting a directional antenna, such as one of the Anritsu Yagi antennas, along with the fast sweep rate of the Field Master Pro MS2090A unit provides a clear picture of RF activity across a wide frequency range and at low power levels.

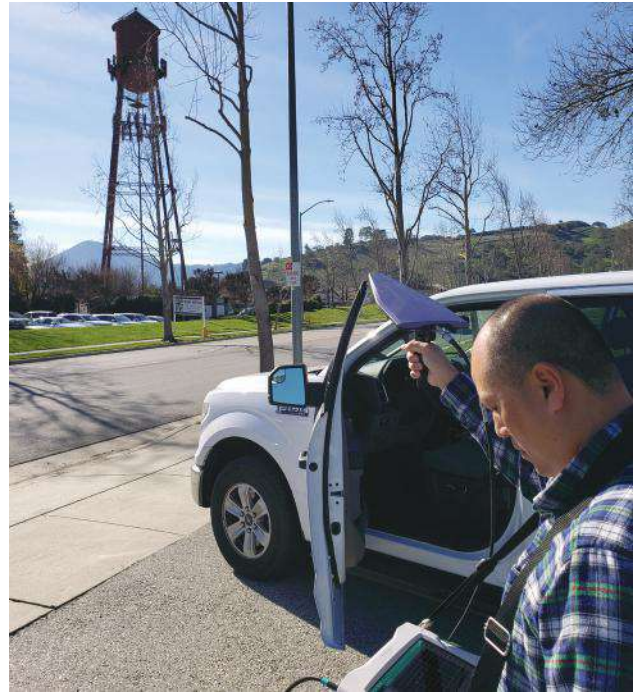

Directional Antennas Used with the Field Master Pro MS2090A Facilitate the Location of Interfering Signals

Field Master Pro MS2090A

APPLICATIONS (Cont'd)

Broadcast Transmitter Analysis

RF transmitters need to be tested at the time of installation and then at regular intervals to confirm they conform to regulatory requirements. The Field Master Pro MS2090A RF spectrum analyzer is ideal for a comprehensive range of transmitter measurements. Harmonic and spurious tests are required to ensure that the transmitter does not interfere with other users of the RF spectrum. These tests can be performed by connecting a cable directly to a test port or over-the-air (OTA) using an accessory antenna. The Field Master Pro MS2090A instrument also has excellent TOI performance and distortion-free dynamic range, ensuring accurate harmonic and spurious measurements to 54 GHz (option dependent).

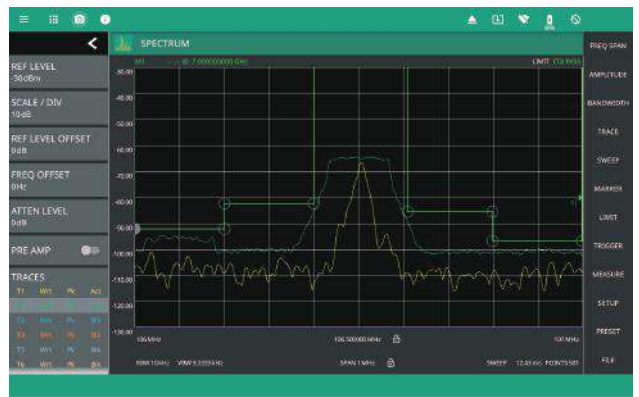

Cross-Border Interference

Cross-border interference between cellular networks has become a significant issue at many international borders. Regulatory authorities often require a measurement of field strength or power flux density (PFD) from the operator before they will initiate any compliance enforcement with the interfering party. The Field Master Pro MS2090A's interference finding features can also be used with its field strength and PFD measurements to check test power levels and create reports required by regulatory authorities for reporting possible power violations. With the field strength setting, users can apply antenna factors either from Anritsu's broad list of tested antennas or from a custom file, giving amplitude results in dBm/m2. Those same factors can be applied to any measurement, including the channel power measurement where the user can then read out the PFD in units of dBm/m2/MHz.

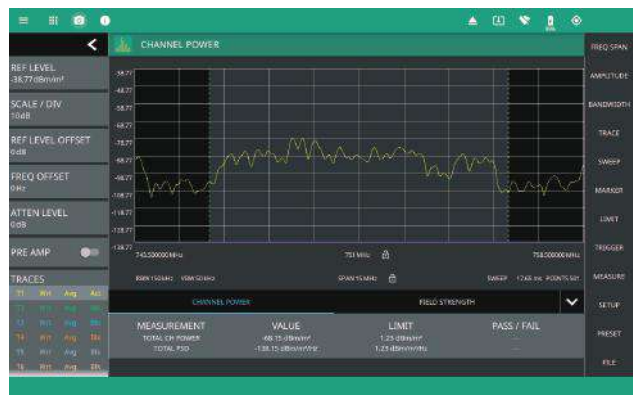

Field Master Pro MS2090A

APPLICATIONS *(Cont'd)*

Microwave Radio Links

Microwave radio links have become central building blocks of cellular and data networks. Installation crews need to align the radios over distances from a few tens of meters to several kilometers. The Field Master Pro MS2090A spectrum analyzer has frequency options to 54 GHz with exceptional sensitivity for dish alignment. Using a waveguide horn antenna, the power and modulation bandwidth can be verified at installation and during maintenance testing.



Pulse Radar Measurements

The wide bandwidth of the Field Master Pro MS2090A enables detailed analysis of pulsed radar signals. In zero span the default bandwidth is 40 MHz and the minimum sweep time is 60 ns, with pulse rise time measurements as short as 20 ns. Up to 12 markers can be positioned on the traces to simplify pulse repetition, pulse width, and rise time measurements. In zero span a fixed frequency IF output option is also available to interface with external analysis tools. To get fully automated pulse characterization with measurements made in compliance with IEEE Std 181-2011, section 5.2.1 add pulse analyzer Option 421.



Satellite System Monitoring

The United Nations Office for Outer Space Affairs estimates there are close to 2,000 active satellites orbiting the earth. Each of these communicates with the ground through dedicated earth stations. Common frequencies for satellite communications have been in the 2 to 4 GHz bands and 4 to 8 GHz bands. Now new bands are opening up in the 12 to 18 GHz, 26 to 40 GHz bands, and even 36 to 50 GHz. As the number of satellites increase so does the opportunity for interference between all the communications. The Field Master Pro MS2090A is ideal for monitoring downlink signals to search for interference and noise.



OPTIONS

Option 888 5G NR Base Station Measurements

The rapid introduction of 5G NR networks requires an instrument that can validate the performance of the gNB base stations quickly in a field environment. In both the 3.5 GHz and (mmWave) 28/39 GHz bands, the adoption of active antenna systems means that new test methods need to be considered. Some radios may have test monitor ports integrated, but many operators will make gNB transmitter measurements OTA.

The Field Master Pro MS2090A high-performance spectrum analyzer performs the essential measurements in full compliance with the 3GPP TS 38.104 V15. Measurements supported include:

- Frequency Error
- Time Offset
- Cell/Sector ID
- Modulation Quality (EVM)
- SS-RSRP, SS-RSRQ, SS-SINR
- Unwanted Emissions
- Occupied Bandwidth
- Adjacent Channel Leakage Ratio
- Transmitter Spurious to 12.75 GHz
- EIRP
- Carrier Aggregation (Up to 8 Carriers)
- Multi-PCI Scanner
- PBCH Constellation

A key part of 5G NR signals is the synchronization signal block (SSB). Decoding the SSB can reveal the important cell characteristics, like cell ID, frequency error, and beam powers. Making measurements on the SSB allows transmitter testing on a live gNB. As well as displaying beam ID, the RSRP is graphed for each of the beams in the SSB. In order to properly decode the signal, the user must know center frequency, bandwidth, and subcarrier spacing of the signal under test. This can be entered manually or by using a 3GPP-defined band and absolute radio-frequency channel number (ARFCN). It is also critical to know the frequency position of the SSB relative to the center frequency of the signal. This can also be entered manually as an offset from center or by entering the global synchronization channel number (GSCN). In cases where the SSB location is unknown, the Field Master Pro MS2090A has an Auto SSB Detect feature that searches the 3GPP-defined raster of potential SSB positions to find it automatically. In some cases, especially in mmWave, a single transmitter can be transmitting up to eight carriers simultaneously. The Field Master Pro MS2090A has a carrier aggregation feature that allows up to eight individual carriers to be set up and measured sequentially in a loop to ensure all are working correctly.

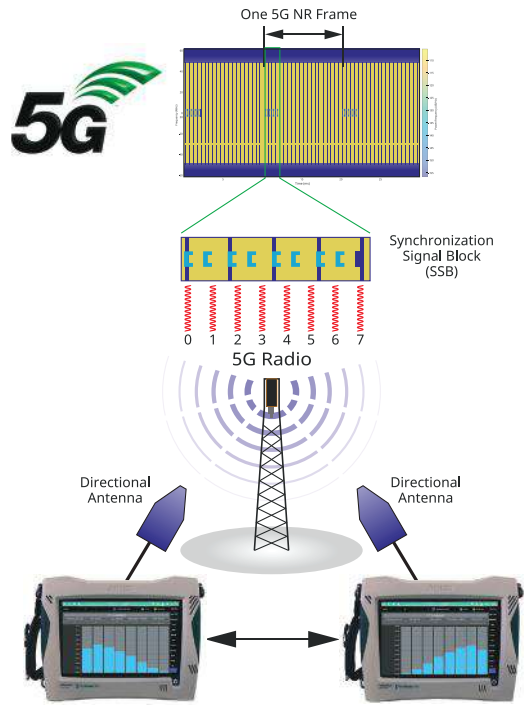

Field Master Pro MS2090A displays RSRP vs. beam index based on OTA analysis of the 5G NR SSB

Field Master Pro MS2090A

OPTIONS (Cont'd)

Where direct access to an RF test connector is not possible, 5G NR installation testing must be performed OTA with a directional antenna or waveguide horn antenna. Because the SSB is always transmitted, the easiest way to test an active gNB is to make measurements on these elements. The Field Master Pro MS2090A decodes all active beams in the signal, typically 8 beams for radios in the 3 to 6 GHz bands and 12 to 64 beams in the mmWave bands around 28 GHz and 39 GHz. A measurement summary screen displays all the essential results to validate base station performance.

In cases where multiple cells are present, it may be helpful to use an omnidirectional antenna to measure the relative power of the different cells and track handover points where the power of two cells is close to equal. The Field Master Pro MS2090A offers a multi-PCI measurement that utilizes advanced software processing to detect all active beams in a given location. The PCI, RSRP, SINR, and EVM of each beam is returned and can then be displayed as an RSRP histogram to monitor relative power or as a table to summarize all results.

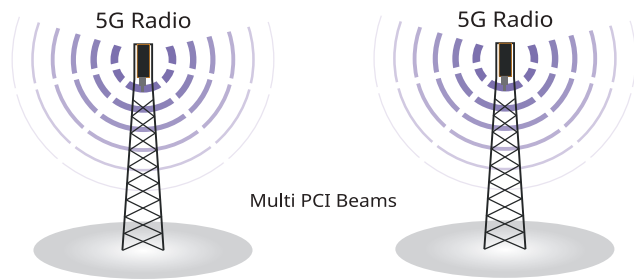

Field Master Pro MS2090A

Field Master Pro MS2090A Offers Multi-PCI Measurements for OTA Testing of One or More 5G NR gNB

Many 5G mmWave gNB transmit four 100 MHz carriers to increase total throughput from a single cell site. These carriers share a common cell ID but have unique ARFCN, GSCN, and SSBs and each needs to be decoded individually. The Field Master Pro MS2090A option supports carrier aggregation measurements as standard. Up to eight carriers with unique settings can be configured and decoded in sequence. The screen displays each carrier power in bar graph format, including the RSRP of the beam with the best SINR, with cell information listed in a table below.

Field Master Pro MS2090A

OPTIONS (Cont'd)

A range of 3GPP-compliant spectrum measurements are supported. To measure gNB transmit power, the Field Master Pro MS2090A instrument includes EIRP and channel power measurements. Both are made OTA using a waveguide horn or broadband antenna to receive the signal. In cases where the gNB can be put into test modes and test model waveforms transmitted, a gated sweep feature enables measurements to be made on defined symbols in the 5G frame. OBW, ACP, and spectral emission mask (SEM) measurements have pre-configured setups to speed testing.



Automated Occupied Bandwidth Measurement Result for a 100 MHz 5G NR Radio

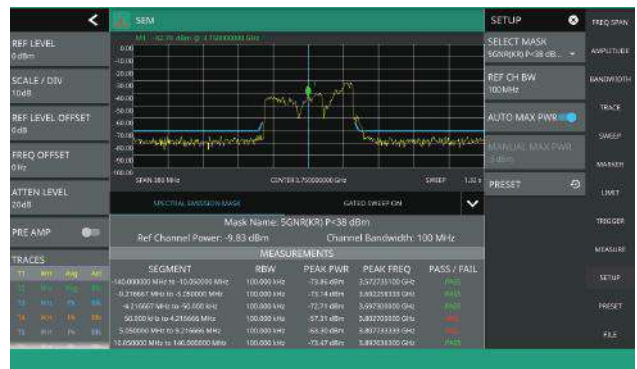

OTA SEM Measurement on a 5G NR Transmission with Pass/Fail Results

The Field Master Pro MS2090A is designed to support EIRP measurements according to 3GPP definition. Section 6 of TS 38.141-2 provides specific definitions and instructions for measuring radiated transmit power. By utilizing a dual polarized directional antenna, users can save the EIRP from each pole and the Field Master Pro MS2090A software will sum them to provide a total EIRP, which equates to the total radiated power of the radio.

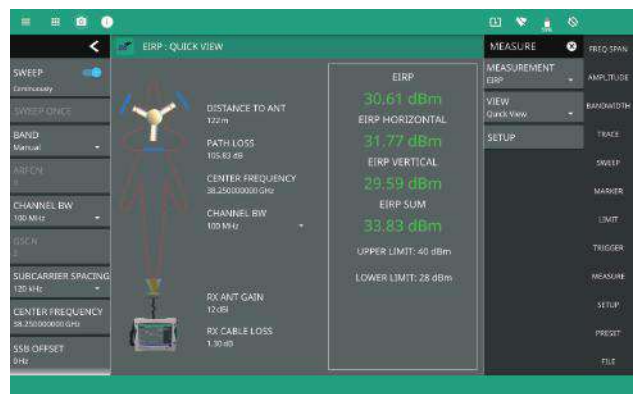

The EIRP Results "Quick View" Screen Provides a Graphical Display of Measurement Configuration and Total EIRP Power

OPTIONS (Cont'd)

Option 883 LTE Base Station Analyzer

The Field Master Pro MS2090A features several measurements for installation and maintenance of LTE FDD and TDD radios. The goal of these measurements is to help maximize data rate and capacity with accurate power settings, ensuring low out-of-channel emissions and good signal quality. These attributes help to create a low dropped or blocked call rate, and a good customer experience. LTE sites also play a critical role in most early 5G deployments, acting as the anchor to 5G communications. Cell site technicians or RF engineers can make measurements OTA to spot-check a transmitter's coverage and signal quality without taking the cell site off-line. When the OTA test results are ambiguous, the user can directly connect the device to the base station to check the signal quality and transmitter power.

The Field Master Pro MS2090A offers the following LTE measurements:

- Cell ID, Sector ID, Cell Group
- Frequency Error
- Time Offset
- PBCH, RS, and SS Power
- Signal Quality (EVM)
- PBCH
- PDSCH (QPSK, 16QAM, 64QAM, 256QAM)
- MIMO Antenna Power and Time Alignment Error (TAE)
- Channel Power
- TDD Frame Power
- Occupied Bandwidth
- ACLR and Spectral Emissions Masks
- Time Alignment Error
- Resource Block Usage
- OFDM Symbol Transmit Power (OSTP)
- Carrier Aggregation
- Multi-PCI Scanner
- Control Channel Measurements
- Constellation Diagrams for PBCH and PDSCH (up to 256QAM)



LTE Results Summary Display

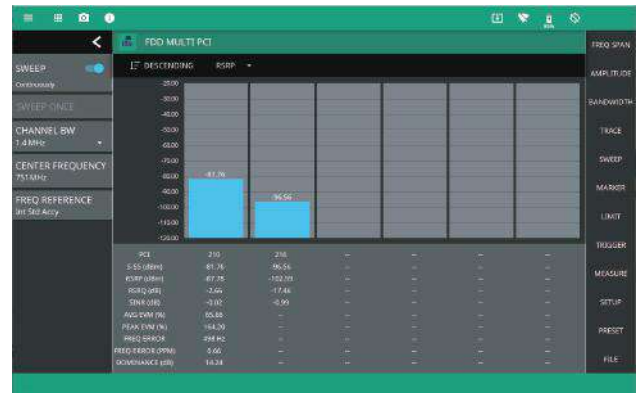

Multi-PCI View Shows Results for All Measured Base Stations on a Single Screen

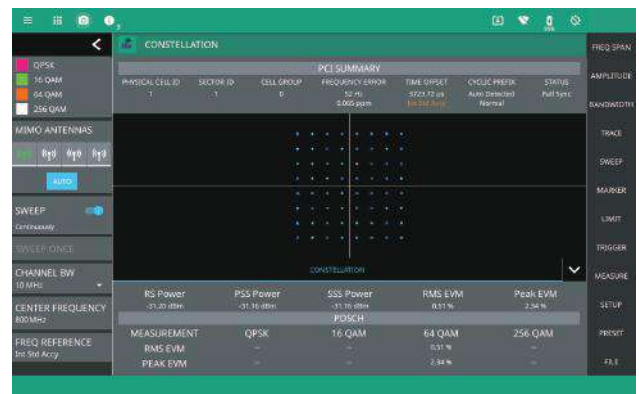

Constellation Diagrams of LTE PBCH and PDSCH Highlight Distortions in Transmitter Modulators

OPTIONS (Cont'd)

Option 199 Real-Time Spectrum Analyzer

For many spectrum and network stakeholders, basic spectrum sweeps may not give enough information. The RTSA option provides real-time signal capture with 110 MHz bandwidth and the ability to capture signals down to a 2.05 μ s duration with 100% POI at full amplitude. This provides unrivaled insight into interference in the wireless spectrum, capturing interfering signals that are too short in duration to be seen with conventional spectrum analyzers yet may be degrading system performance. A power spectral density display shows the relative time that RF power is present at all levels and frequencies within the capture span. This is a powerful tool to find interfering signals within the same band as known/wanted signals. The spectrogram displays the maximum output of the RTSA fast Fourier transform (FFT) over time with settable 50 ms to five seconds resolution. The spectrogram provides a history of spectral activity enabling intermittent interferers to be detected and recorded.

Option 124 IQ Capture

The Field Master Pro MS2090A also offers options for IQ waveform capture (Option 124) and IQ waveform streaming (Option 125) to enable detailed offline analysis of signals captured OTR. The 2 GB of internal memory is allocated to IQ captures, enabling data capture at 200 mega samples per second with 110 MHz capture bandwidth for up to five seconds. Once captured, data files can be exported by USB memory devices to a PC for post processing. The single capture mode triggers one event and then waits for a new trigger event before initiating further captures. The continuous capture mode initiates sequential captures to a new file without additional triggering until stopped by the user.



RTSA with Spectrogram Display Provides Detailed Insight into Signal Behavior

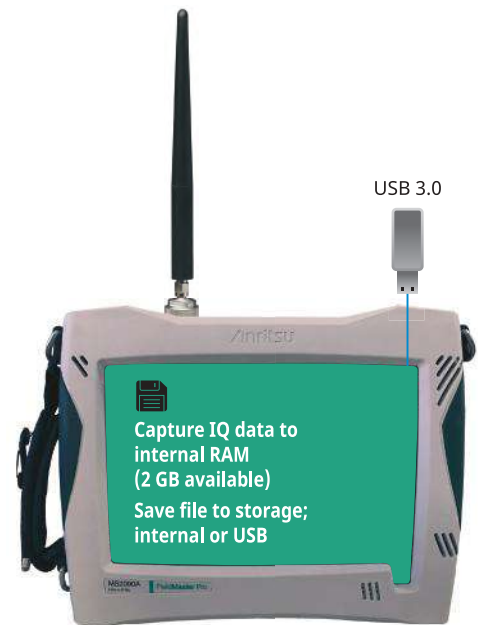

Free Run, External, Video, and Level Trigger Options are Available in the RTSA Mode to Initiate IQ Data Capture

Field Master Pro MS2090A

OPTIONS (Cont'd)

Option 125 IQ Streaming

For users who need more data over a longer period of time, the Field Master Pro MS2090A supports gapless streaming of data over Ethernet, USB 3.0, over PCIe interface or directly to the X-COM IQC5000B series RF record and playback system (bandwidths dependent on transfer speeds).

Interface	Max Data Rate (MB/s)	Max IQ Bandwidth/Bits
Ethernet	>100 MB/s Network Dependent	40 MHz/10 bits
USB 3.0 SS Drive	>250 MB/s	100 MHz/8 bits
X-COM IQC5000B	>800 MB/s	110 MHz/16 bits
PCIe	>800 MB/s	110 MHz/32 bits* (*see data sheet for requirements)

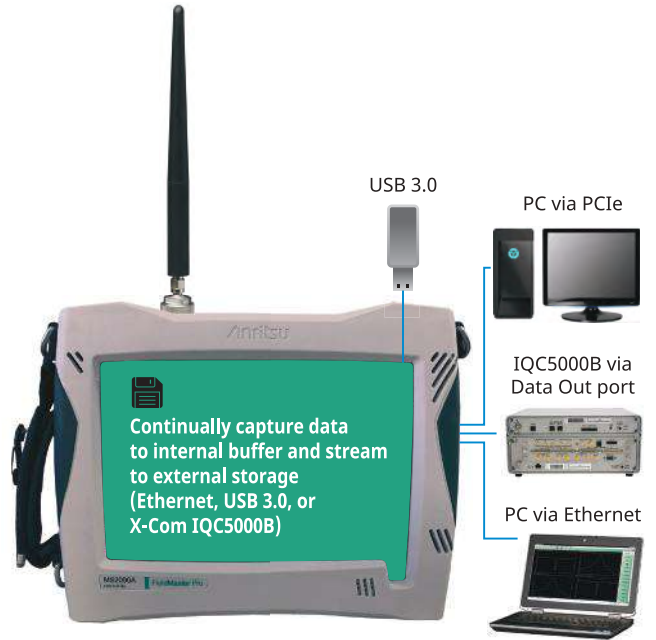

Following the capture of IQ data, post processing on a PC is used to analyze the signal in greater detail. Information on the IQ data format is explained in detail in the instrument user guide for anyone using custom Matlab, Python, etc. tools. The Field Master Pro MS2090A IQ files can also be analyzed by commercial IQ analysis applications and the data can be easily converted to .xdat format for evaluation with X-COM Spectro-X data analysis tool.



Continuous Update of the RTSA is Supported even When Streaming IQ Data

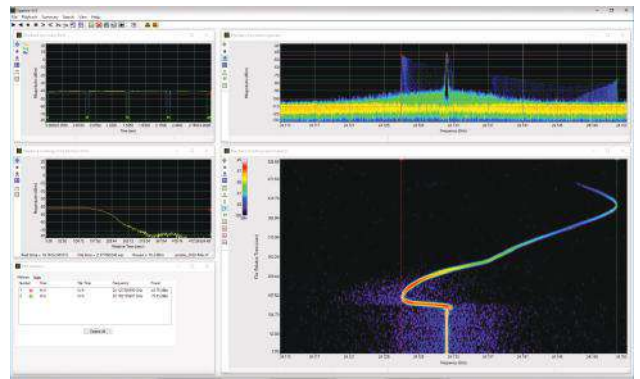

IQ file Compatibility with X-COM Spectro-X Software for Post-Processing can Highlight Detailed Information on a Radar Pulse Pre- and Post-Signal Drift with μ s Resolution

OPTIONS (Cont'd)

Option 331 S331P Site Master Support

Connect a Site Master S331P ultraportable cable and antenna analyzer (CAA) to any of the Field Master Pro MS2090A USB ports for base station tower RF cable and antenna feed measurements. The Site Master S331P is a pocket sized CAA that interfaces to the Field Master Pro MS2090A via USB cable. The small form factor simplifies testing as the test port can be presented to the cable under test without the need for test port extension cables.

The Site Master S331P is available in two frequency ranges, 150 kHz to 4 GHz that covers the common PMR and cellular bands and the 150 kHz to 6 GHz model covers all of the 5G NR FR1 band. The CAA user interface was developed using over 20 years experience of line sweeping measurements in the field. The Site Master S331P delivers the fastest sweep speeds in a field portable instruments making it ideal when searching for faults and monitoring results traces while tapping connectors and cable clamps. A dual measurement display show VSWR (Return Loss) and distance-to-fault (DTF) on a single screen.

Calibration is achieved with traditional OPEN/SHORT/LOAD calibration accessories, or when quick results are required for the factory ReadyCal speeds measurements. A calibration wizard guides users through the calibration process to speed and simplify operation. The RF immunity mode rejects measurement errors when testing OTA in the presence of other RF transmitters. All common cable performance data is stored in memory and generation of close out reports is simplified with file formats that can be read into Anritsu's industry standard Line Sweep Tools PC results processing application.



Simultaneous Display of Cable and Antenna Feed Return Loss and Distance to Fault



Calibration Wizards Simplify the Calibration Process to Ensure Accurate Results



The Small Form Factor of the S331P Enables Direct Connection to the Cable Under Test Without the Need for a Test Port Cable

OPTIONS (Cont'd)

Option 128 Vector Signal Analysis

The MX280005A Vector Signal Analysis PC software is designed to perform physical layer modulation analysis of common communication transmitter signals. When Option 128 is enabled on the Field Master Pro MS2090A, the IQ files captured are signed, facilitating their post processing and analysis using the MX280005A PC software. During the design and manufacturing stages of a wireless communication system, it is common to measure the modulation quality with benchtop instruments. Using the IQ capture option of the Field Master Pro MS2090A together with the MX280005A software, these measurements can be validated in a field environment.

Framed and unframed signals are supported. In framed mode, the software decodes common wireless signals including public safety (TETRA, P25, DMR) to aerospace and satellite communications. In unframed mode, the software analyzes continuous modulation such as DQPSK, QAM, ASK, and FSK. The Field Master Pro MS2090A supports IQ captures up to 110 MHz bandwidth, meaning narrowband communications signals or wideband satellite downlink signals can be captured and analyzed with the same application.

MX280005A software can initiate the capture of IQ data from a Field Master Pro MS2090A over an Ethernet connection or a data capture can be triggered manually through the Field Master Pro MS2090A touchscreen. Multiple analysis formats are provided including signal spectrum, EVM, constellation diagrams, eye diagrams, and numeric result tables. A comprehensive insight into all aspects of the transmitter performance is provided as multiple results windows can be displayed simultaneously.

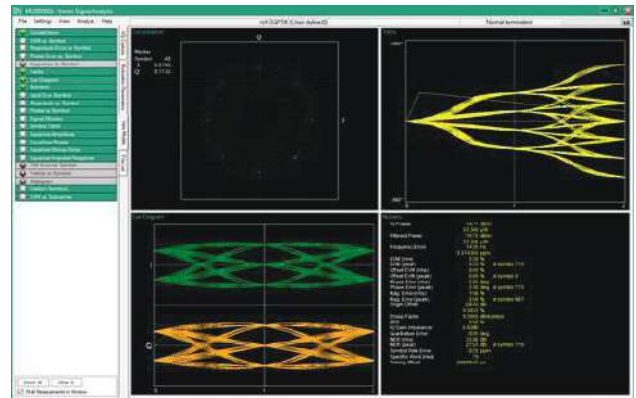

MX280005A Single Screen Multiple Results Vector Signal Modulation Windows

Field Master Pro MS2090A

OPTIONS (Cont'd)

As networks get denser and new radio transmissions are added to the environment, it will continue to be critical to monitor the electric field power levels to ensure public safety. The Field Master Pro MS2090A offers two solutions for regulators or network operators to make measurements of the electromagnetic field.

Option 444 EMF Measurements (9 kHz to 6 GHz)

Option 444 uses the spectrum analyzer sweep and a tri-axial isotropic antenna to measure field strength in frequency-specific bands in all spatial directions. This is useful for both LTE and 5G FR1 to ensure radios are not transmitting excessive power. Three antennas are supported, providing frequency coverage from 9 kHz to 6 GHz. Antennas are individually calibrated and the instrument reads the calibration data through the USB interface. The same interface is used to switch rapidly between the three antennas orientations to provide complete 3 axis isotropic measurements. The Field Master Pro MS2090A displays the results of each axis on the spectrum display and a table presents a summary of measurements including peak and average field strength and measurement time. The total measurement time and axis dwell time and limits are user settable or can be defaulted to ICNIRP values.

Option 445 EMF Meter (20 MHz to 40 GHz)

Option 445 supports the 2000-1985-R EMF Probe, which makes broadband field strength measurements in the 20 MHz to 40 GHz band. With 5G FR2 and all other mmWave technologies now mixing with existing lower frequency applications, this is an excellent tool for ensuring that overall EMF power is not exceeding FCC or ICNIRP limits in a given location. The probe automatically returns the average and maximum power for each of the three axes. Typically this probe is used for confirming that the RF field strength close to mmWave 5G NR radios does not exceed the ICNIRP consumer or technician health and safety levels. At any given position, once measurements are initiated, the results are displayed as a peak and average bar chart with the current field strength reading as a percentage of ICNIRP limits. The 2 meter interface cable between the instrument and probe enables the probe to be cycled between ground level and up to 2 meters above the ground to identify field strength maximums. Up to 16 measurement positions can be recorded at a given test site, for example on a rooftop where a new 5G mmWave radio is being installed. Results can be saved to memory for later analysis and report generation.



Field Master Pro MS2090A with the 2000-1791-R Isotropic Antenna



EMF Results Show Power from each Antenna Axis and Summary Results for Peak and Average Power over a Defined Time Period



Field Master Pro MS2090A mmWave EMF Meter with 2000-1985-R EMF Probe



EMF Meter Displays Percentage of ICNIRP Limit over Time at Up to 16 Positions at Any Given Site

OPTIONS (Cont'd)

Option 400 and 407 Vision™ Monitor Software

Vision Monitor software offers a range of applications for monitoring the RF spectrum over a period of time and storing results to a database. Vision Monitor is an ideal tool for long-term interference monitoring. Limits can be set with automated alarms for limit violations to capture short-term or intermittent signals. Other features include a scanner option that enables the monitoring of a range of frequency bands or channels over time with unique settings for each channel being monitored. A multi-trace view shows the spectrum for all channels being monitored on the same display.

The Vision Monitor application is fully automated. Measurements can be captured and periodically uploaded to a database for further processing. Depending on need and storage capacity, users can store spectrum history over many months or years with a user-defined capture assigned schedule.

All spectrum measurement databases are searchable, allowing the user to quickly locate patterns of signal activity relevant to an investigation. The spectrum history can also potentially be used in legal proceedings for documenting illegal or unlicensed broadcast activity. Other functions provided by Vision Monitor include:

- Threshold and trace mask settings for alarm generation
- Email alert sent when threshold violation generates an alarm
- Reporting on spectrum integrity on a daily or weekly basis
- Vision runs on a PC/laptop using the Windows® operating system (Windows 7/8/10)

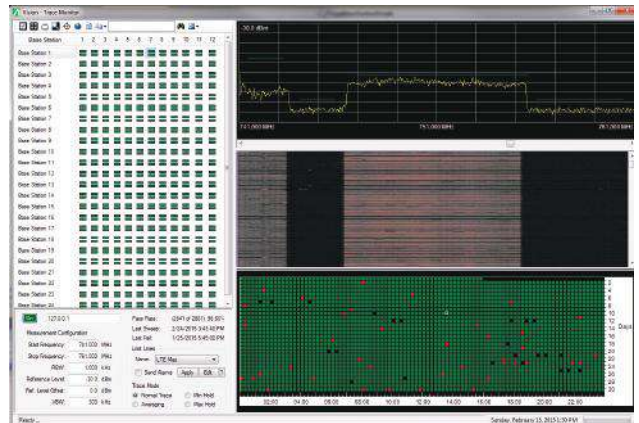

Vision Monitor Simultaneously Displays Current Spectrum, Spectrogram, and Pass/Fail History over an Extended Time Period on a Single Screen



Vision Monitor Trace Viewer Provides Live Spectrum Analysis from Multiple Channels on a Single Screen for Wide Area Monitoring

Field Master Pro MS2090A

OPTIONS (Cont'd)

Mobile InterferenceHunter™ (MIH) MX280007A

Anritsu's Mobile InterferenceHunter MX280007A is a quick and reliable way to find single or multiple sources of interference that are degrading the performance of an RF communications network. MIH can distinguish between multiple signal sources, reflections, RF shadows, drifting signals, bursty signals, and multi-path transmitters making it a cost effective solution for a wide range of interferers.

Interference hunting is achieved by applying proprietary algorithms to channel power data captured with geolocation positioning information during an area drive in a vehicle.

When used with Field Master Pro MS2090A, MIH provides interference hunting and spectrum clearing capability from 9 kHz to 54 GHz. The Mobile InterferenceHunter MX280007A is a quick, reliable, and multi-emitter enabled solution to interference hunting and spectrum clearing needs.



MIH System Installation with Large In-Vehicle Display and Omni Antenna on Roof

Option 421 Pulse Analyzer Measurements

The pulse analyzer option for Field Master Pro MS2090A provides automated measurements and characterization of pulse signals. Pulsed RF signals are common in military and civil radar as well as industrial sensors and medical therapeutics. Validating the performance of any pulsed RF system will require detailed knowledge of the pulse characteristics. The Field Master Pro MS2090A pulse analyzer option automates the capture and display of pulsed signals, providing a comprehensive readout of all standard measurements. The large 10.1 inch screen provides graphical display and numeric results on a single screen. Common pulse measurements (including pulse power, peak power, rise/fall time, and pulse width and repetition frequency) are all calculated automatically. Rise times as short as 20 ns can be measured when Option 104 is enabled. Simply set up the trigger level, trigger delay, and capture time to display the pulse graphically on the display and all measurements are performed automatically. The position of key parameters, including 10% and 90%, rise time and peak power are highlighted by on screen marker lines. To ensure measurement traceability, all pulse measurements are compliant to IEEE Standard for Pulses and Related waveforms (181-2011).



OPTIONS (Cont'd)

Option 24 Interference Finder

Having confirmed the presence and frequency of an interfering signal with the spectrum analyzer or RTSA, the next task is to pinpoint its location. If the location is completely unknown, the MIH provides the best route to locate the location within a block in urban environments. The interference hunter mode is ideal for locating an individual building or even a specific floor within a building. The interference hunter is used in conjunction with a directional antenna to locate the direction of an interfering signal. This feature emits an audio tone whose pitch and volume is proportional to the strength of the detected signal. By sweeping a directional antenna in an arch, the tone gives a clear and rapid indication of the direction of the interfering source. Simply pointing the antenna towards the source of interference causes the tone to increase in pitch and level, speeding the location search of even the most elusive of signals.

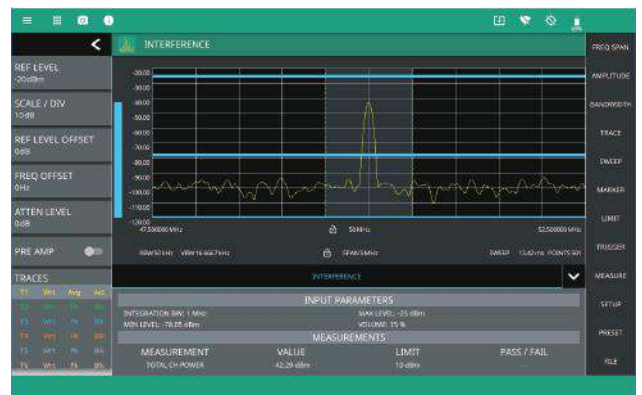
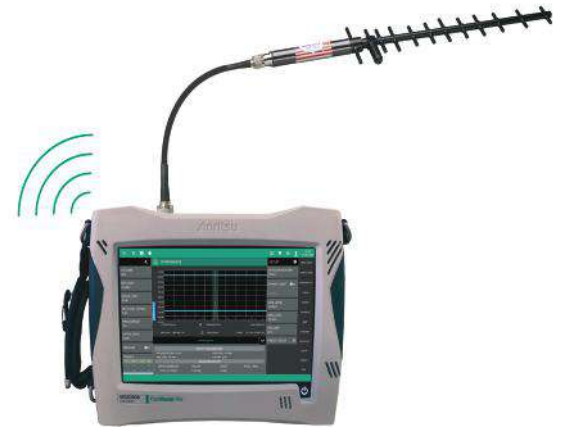

Interference Finder Option 24 Provides Fast Audio Tone Response to Changing Interference Levels

Included in Option 24 is an AM/FM audio demodulator. When an interfering signal has been discovered, the audio demodulation can provide excellent insight into the origin of the source. Broadcast commercial radio stations can be identified by listening to the demodulated speech or music. Other interference sources also create characteristic audio sounds, for example a rotating radar will result in a regular periodic audio swoosh, audio white noise is typically the result of faulty light fitting or industrial machinery that is poorly suppressed and pops and crackles often indicate environmental causes such as wind blowing cables and brackets against each other.

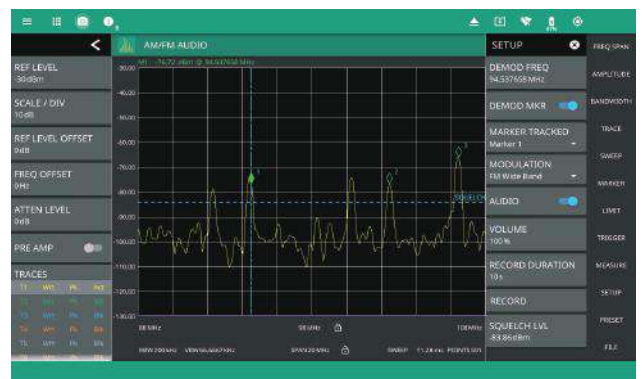

AM/FM Demod

The AM/FM demodulator includes the ability to save the demodulated audio as a .wave file for post site analysis.

Field Master Pro MS2090A

OPTIONS (Cont'd)

Option 431 Coverage Mapping

The Field Master Pro MS2090A supports comprehensive coverage mapping options. Communications network and system operators need a clear understanding of network coverage over a wide area, this facilitates conformation of actual performance against modeling to ensure that all users have good network coverage. New base stations can be planned for areas where coverage does not meet expectations.

The Field Master Pro MS2090A coverage mapping option displays detailed digital maps on the instrument touchscreen and overlays breadcrumbs on the map whose color indicates signal strength at that location. Maps are downloaded directly into the instrument from a dedicated web site, simply connect the instrument to the internet using its Ethernet or Wi-Fi interfaces and highlight the area on the world map that you want to download. Once downloaded, maps are stored in internal memory.

Once installed, maps can be moved around the screen and expanded using the same pinch and zoom gestures with your fingers that are used on a smartphone.

Anritsu offers a range of broadband omnidirectional RF antennas with integrated GNSS antennas to magnetically mount on the roof of a vehicle. When undertaking a coverage mapping drive in a vehicle, the Field Master Pro MS2090A drops breadcrumbs on the map display whose color represents signal strength in real-time. Signal strength is selected between channel power, RSSI, or spectral density. The spectral density setting is specifically required for monitoring the signal strength at international borders for which permitted cross border signal leakage is defined by international treaties. Breadcrumbs can be positioned at user defined distance intervals or on a regular time interval.

When the drive is complete the data can be saved in .kml format for post processing in standard digital maps such as Google Earth or a standard measurement file to recall on the Field Master Pro MS2090A display at a later time.

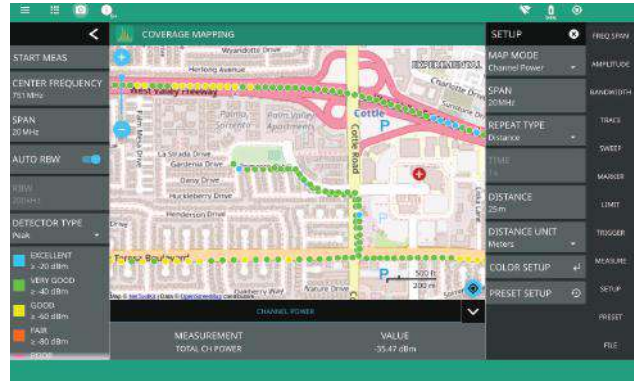

Color Coded Breadcrumbs Show Changes in Signal Strength Along the Route

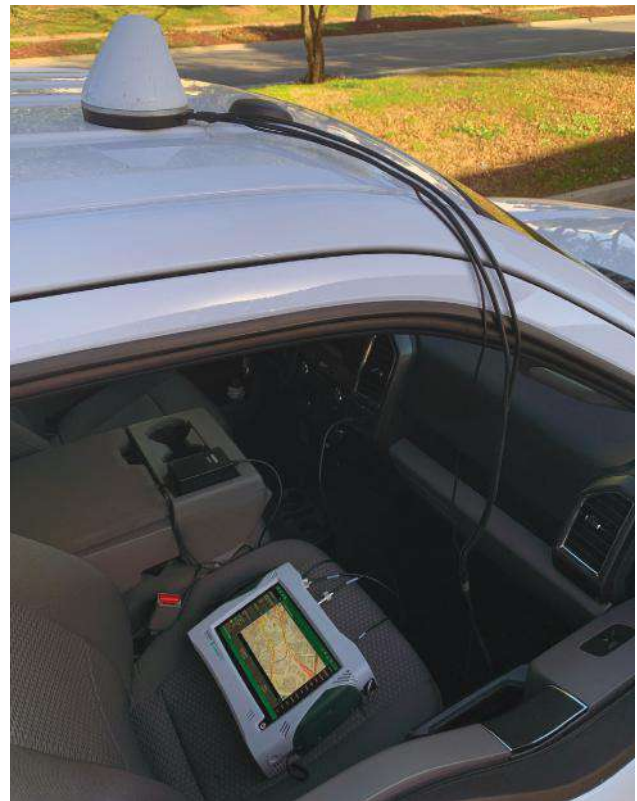

The Accessory Magentic Mount Antenna Completes the Solution for In-Vehicle Applications

Field Master Pro MS2090A

OPTIONS (Cont'd)

In addition to outdoor coverage mapping using digital maps, Option 431 includes an indoor mapping capability. For indoor mapping applications, a .jpeg or .png image is imported into the Field Master Pro MS2090A and displayed on the screen. Typically, this would be the floor plan of the building to be mapped. The user walks around the floor plan and their current location is entered on the displayed map with a simple touch of the screen. MS2090A distributes signal strength measurements along the path taken by the user enabling full RF signal coverage of the inside of the building to be assessed.

5G and Indoor Coverage Mapping with NEON® Signal Mapper

For indoor coverage mapping a NEON Tracking Unit is required in addition to NEON Signal Mapper software for Android devices and NEON Command software for a PC. The NEON Tracking Unit provides the collection and processing of sensor data that delivers 3D location information inside a building in real-time, without the need for any GNSS connection. The NEON Tracking Unit connects to the NEON Signal Mapper MA8100A application that is run on an Android device. The NEON Signal Mapper MA8100A application provides an intuitive Android user interface, enabling trained users to map RF signals within buildings. RF data is captured by Field Master Pro MS2090A unit and the data is sent to the Android device.

NEON also supports outdoor coverage mapping applications, the Field Master Pro MS2090A instrument provides both location by GNSS connectivity and RF data directly to the Android device. The application shows which SSB beam is recording the highest signal level and PCI information for each data point when the instrument is in 5G demod mode.



Typical Result Screen for Indoor Coverage Mapping

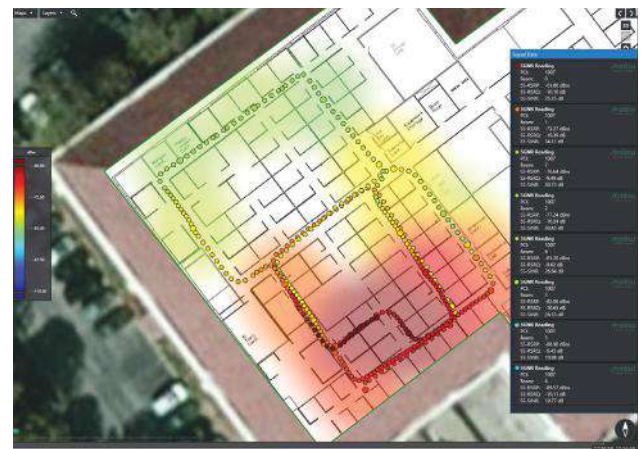

3D Indoor Maps with Base Station Data are Generated by the NEON Signal Mapper

Field Master Pro MS2090A

OPTIONS (Cont'd)

Option 19 High Accuracy Power Meter

The Field Master Pro MS2090A delivers power meter accuracy power measurements when coupled with Anritsu's USB power sensors. The following USB sensors can be connected directly to any of the Field Master Pro MS2090A USB ports.

Microwave CW Power Sensors

- MA24330A/MA24340A/MA24350A

Universal Power Sensors

- MA24208A/MA24218A

RF CW Power Sensors

- MA24108A/MA24118A/MA24126A

Average Power Sensor

- MA24106A

When using the Field Master Pro MS2090A to install a new cellular or LMR base station, it is important to set the transmitter power precisely. Too much transmit power can result in interference with other transmitters or adjacent cells and too little power results in reduced cell site coverage.

Option 19 provides a traditional analog power meter display with a fast responding needle and complimentary digital read out. Limit lines with audible alarms aide testing to defined specifications and a Max Hold feature is ideal when tuning for maximum power.

Select the MA241xxA series sensors for RF CW and MA243x0A series sensors for microwave CW measurements. The power sensors MA242xxA have a cascaded diode architecture to enable accurate power measurements on modulated signals. The sensors are powered over the USB cable so no additional batteries are required.

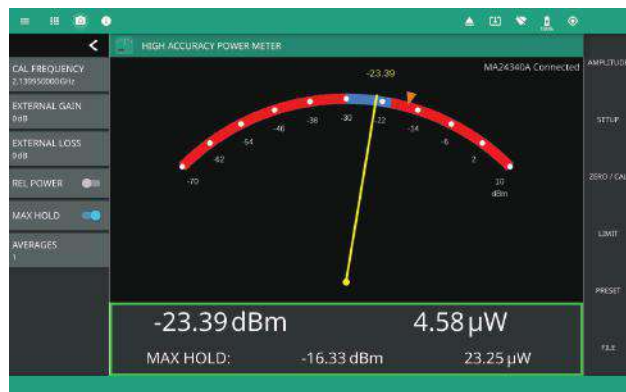

Option 19 Provides Power Meter Accuracy with a Large Analog Display Plus Digital Readout

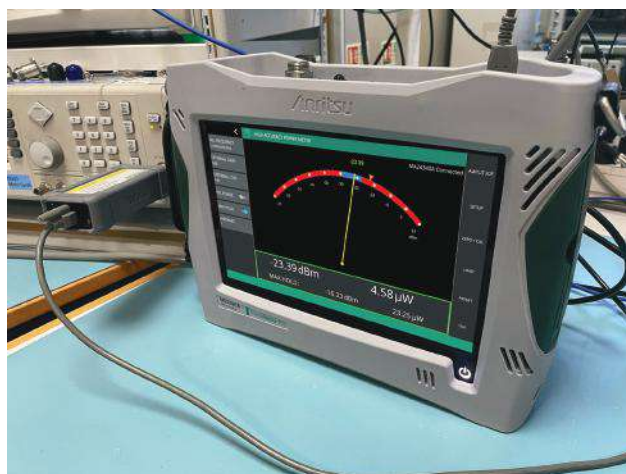

A Range of USB Power Sensors Offer Power Meter Accuracy up to 50 GHz

KEY FEATURES

Multiple Traces and Detectors

Up to six traces can be displayed simultaneously, with each trace able to use different detector and averaging. Each trace is color-coded with an information table highlighting the detector type, averaging, and status of each active trace.

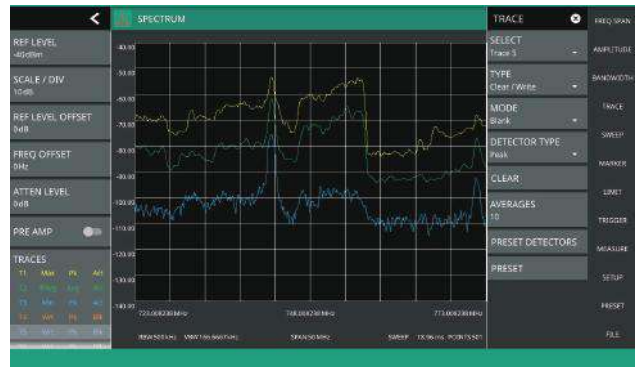

Comprehensive Markers

Markers, with detailed results table, enable recording and archiving of results. A noise maker can be activated for noise power measurements in a 1 Hz bandwidth, and each marker can be set to initiate a true frequency count at the end of a sweep. Peak search options can be seen by double tapping a marker to open the search option.



Limit Lines with Pass/Fail

Flexible limits, from simple maximum level lines to complex envelope shapes, provide automated pass/fail indication and can be used to trigger remote alarms. Limits can be entered manually to conform to international standards or automatically generated based on the signals measured in the current trace. The instrument will save the trace data any time the trace crosses a limit line. This is useful in the case of intermittent interference where the user can set the limit line and capture the right information automatically when it crosses the line.



Zero Span

Selecting zero span in the spectrum analyzer mode enables the analysis of pulsed and time varying signals. Zero span is ideal for capturing the profile of short duration radar pulses and validating the length of data packets in wireless systems. Comprehensive markers facilitate the measurement of pulse width, pulse repetition frequency, and pulse rise time. A 40 MHz resolution bandwidth in zero span allows a minimum sweep time of 60 ns to be set and measurement of rise time as short as 60 ns to be measured.

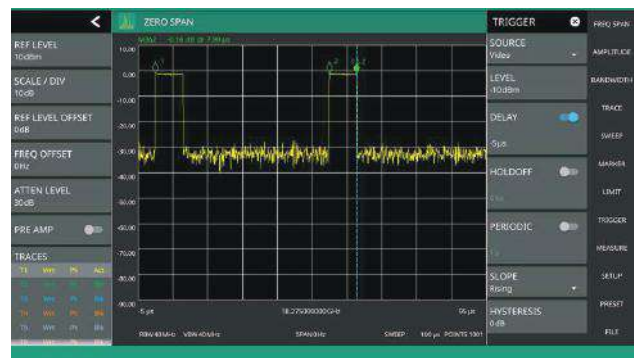

Field Master Pro MS2090A

KEY FEATURES (Cont'd)

Spectrogram

The combined spectrum and spectrogram display shows activity over time in a given spectrum band.

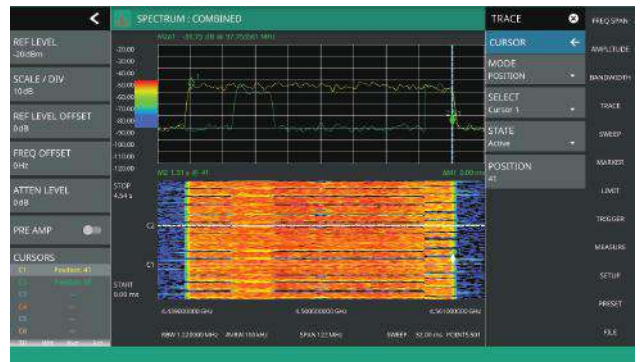

Smart Measurement

The Field Master Pro MS2090A includes smart measurements for channel power, occupied bandwidth, adjacent channel power, and spectral emission mask. Smart measurements provide dedicated set up menus to quickly configure the instrument and display results in industry-standard formats. For TDD radios, a gated sweep feature captures data only when the radio is transmitting, providing accurate and stable measurement results.

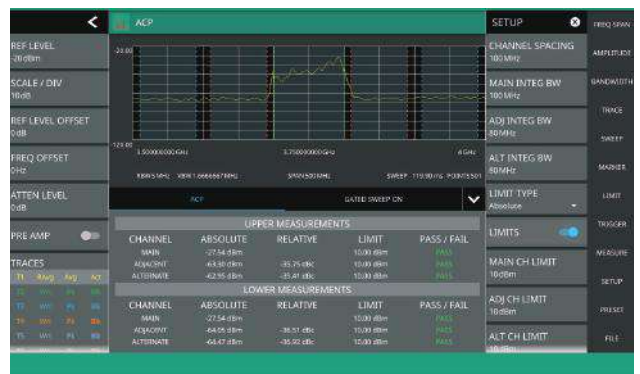

Trace Record and Playback

Trace record and playback is ideal for monitoring spectrum for detailed analysis at a later time. Spectrum traces can be recorded over extended periods of time and saved to internal memory. When playing back the trace file, the playback can be slowed down to view transient and intermittent events that are hard to see in real-time. Spectrograms can be activated on recorded data even if not enabled during the recording session, and trace averaging and masks applied.



Quasi Peak Detector

A Quasi Peak (QP) detector is available for EMC pre-compliance testing. The QP detector is fully compliant with the requirements of CISPR 16-1-1 for measurements up to 1 GHz and the required 200 Hz, 9 kHz, or 120 kHz filter is automatically applied for the selected frequency. Multiple signals on a spectrum sweep can be identified by markers for measurement with a QP detector. Regulators also benefit from QP detectors when interference hunting pulsed signals.



Field Master Pro MS2090A

Remote Control and Connectivity

Full remote control of all instrument functions are available using the standard Ethernet interface. The Field Master Pro MS2090A conforms to standard SCPI protocols. 802.11b/g/a/n connectivity is also supported. The Field Master Pro MS2090A connects to Wi-Fi routers enabling remote control of the instrument using IP protocols. A remote desktop tool comes standard with the Field Master Pro MS2090A solution, enabling control of the device over an internet and Wi-Fi connection from any location. For facilities where network security is paramount, Option 6 removes the Wi-Fi hardware, eliminating any security concerns that wireless connectivity may raise.

The USB Test and Measurement Class (USBTCM) standard is supported through the USB Type C connector. This interface is specifically designed for remote control of test instruments through a standard USB interface with the supporting protocol. It is a plug and play interface. A typical use case is to control the Field Master Pro MS2090A from a customer written application running on an Android smartphone. By connecting to a smartphone with a USB Type C cable, applications can configure the Field Master Pro MS2090A, and read measurement results back into the smartphone. These results can then be compiled into a report and sent to a central location using the smartphone cellular data plan.



Field Master Pro MS2090A Can be Controlled by an Android Smartphone

The Field Master Pro MS2090A PC Tools Remote GUI and Control

A freely downloadable PC application provides a remote user interface. Users can take full control of the Field Master Pro MS2090A from any remote location using this PC application. The GUI is an exact copy of the instrument touchscreen and can be used for remote instrument control or results and trace monitoring. The tool enables saving of traces directly to the PC file system where markers and limit lines can be added and adjusted retrospectively.

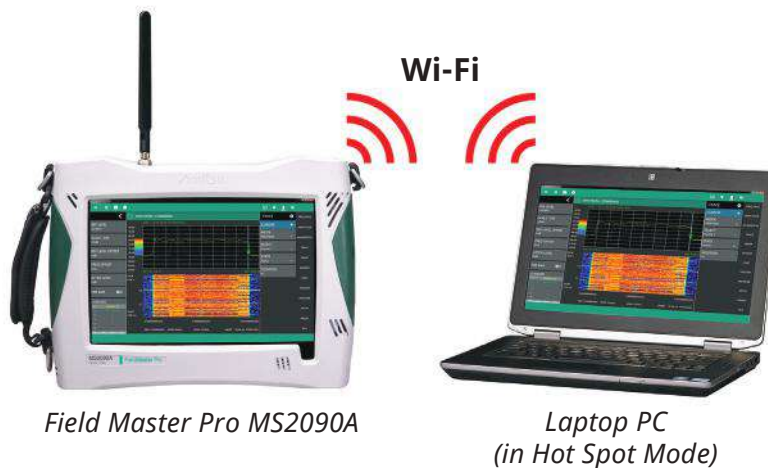

Field Master Pro MS2090A

Comprehensive Interface Selection

The Field Master Pro MS2090A spectrum analyzer comes standard with: 3 x USB 3.0 type A host ports; 1 x USB 3.0 Type C device port; and, Data Out and microSD interfaces. USB 3.0 host interfaces can be used to save screen images such as a .png or IQ data files, IQ data streaming, and facilitate software or option updates. The Data Out port is used for high-speed IQ streaming. USB Type C and microSD are provided to support future applications.

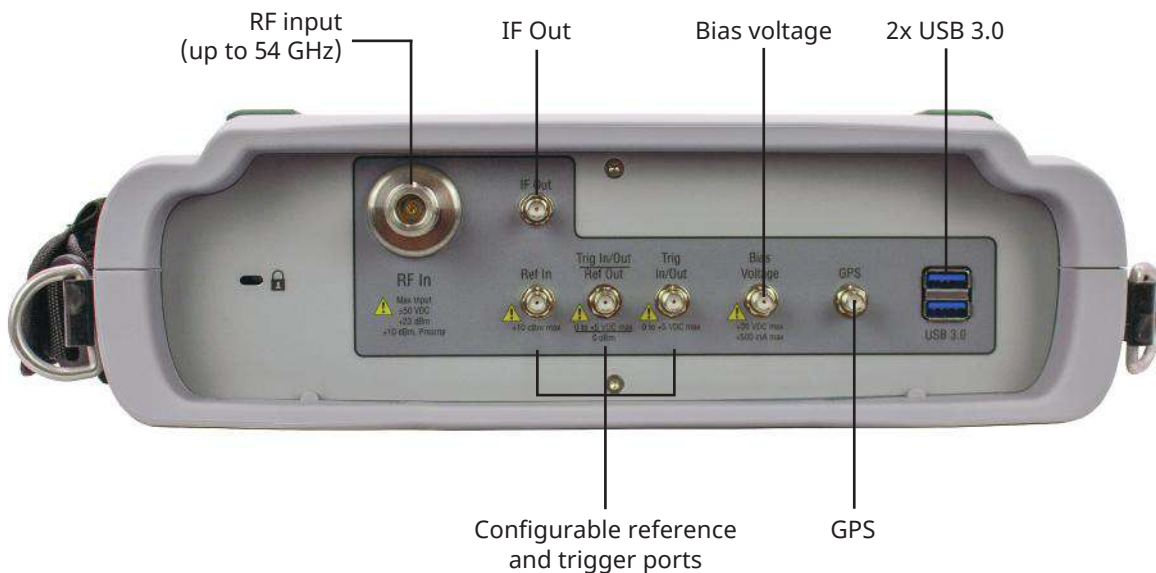
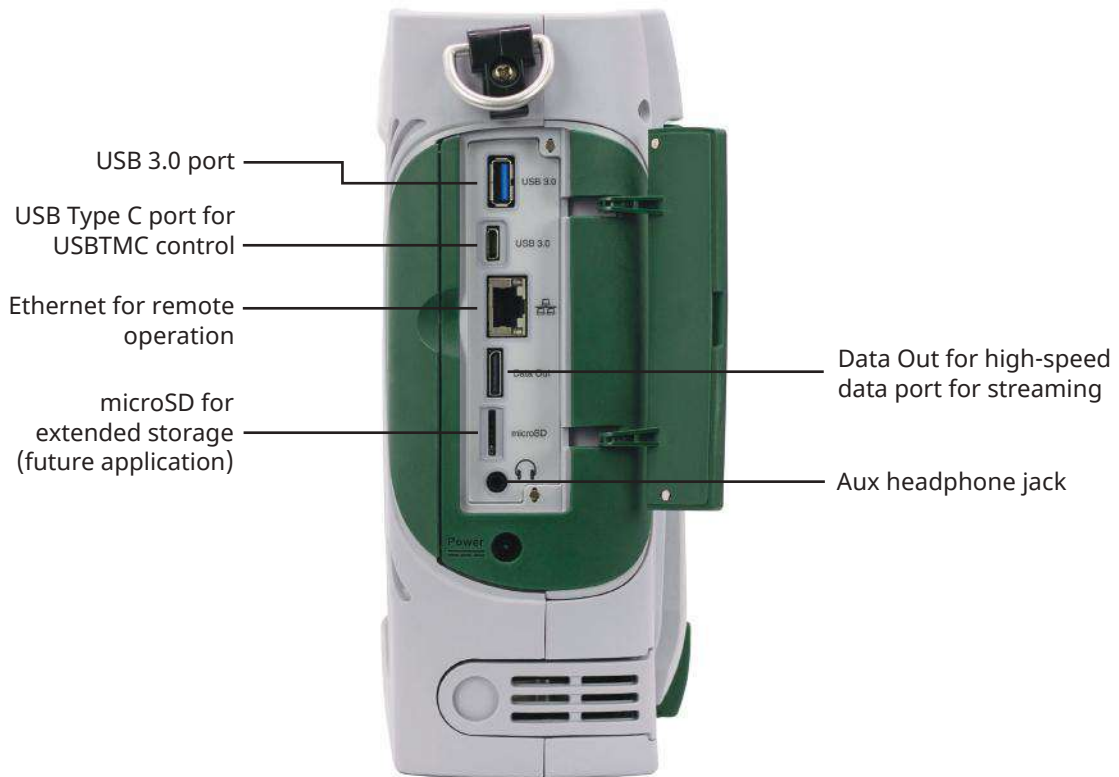

Ordering Information

Part Number	Description
MS2090A	Field Master Pro (Requires Option 709, 714, 720, 726, 732, 743, or 754)
Options	
MS2090A-0006	Remove Wi-Fi
MS2090A-0019	High Accuracy Power Meter (Requires USB Power Sensor, Sold Separately)
MS2090A-0024	Interference Hunter
MS2090A-0031	GPS Receiver (Requires GPS Antenna, Sold Separately)
MS2090A-0089	Zero Span IF Output
MS2090A-0090	Gated Sweep
MS2090A-0103	55 MHz Analysis Bandwidth
MS2090A-0104	110 MHz Analysis Bandwidth
MS2090A-0124	IQ Waveform Capture
MS2090A-0125	IQ Waveform Streaming (Requires Option 124)
MS2090A-0126	IQ Waveform Capture (Non-Export Controlled)
MS2090A-0127	IQ Waveform Streaming (Non-Export Controlled, Requires Option 126)
MS2090A-0128	Vector Modulation Analysis Software enabled
MS2090A-0199	Real-Time Spectrum Analyzer
MS2090A-0331	S331P Site Master enabled (Requires S331P, Sold Separately)
MS2090A-0400	Vision Monitor Enabled
MS2090A-0407	Vision High-Speed Port Scanner Enabled
MS2090A-0421	Pulse Analyzer
MS2090A-0431	Coverage Mapping
MS2090A-0444	EMF Measurement (Frequency Selective, Requires Anritsu Istropic Antenna)
MS2090A-0445	EMF Meter Enabled (Broadband, Requires 2000-1985-R Isotropic EMF Probe, 20 MHz to 40 GHz)
MS2090A-0709	Frequency Range 9 kHz to 9 GHz
MS2090A-0714	Frequency Range 9 kHz to 14 GHz
MS2090A-0720	Frequency Range 9 kHz to 20 GHz
MS2090A-0726	Frequency Range 9 kHz to 26.5 GHz
MS3090A-0732	Frequency Range 9 kHz to 32 GHz
MS2090A-0743	Frequency Range 9 kHz to 43.5 GHz
MS2090A-0754	Frequency Range 9 kHz to 54 GHz
MS2090A-0883	LTE FDD and TDD Measurements (Requires GPS Option MS2090A-0031)
MS2090A-0888	5G NR Downlink Measurements (Requires GPS Option MS2090A-0031)
MS2090A-xxxx-0097	Accredited Calibration to ISO17025 and ANSI/NCSL Z540-1 (xxxx is the Frequency Option Number)
MS2090A-xxxx-0098	Standard Calibration to ISO17025 and ANSI/NCSL Z540-1 (xxxx is the Frequency Option Number)
MS2090A-xxxx-0099	Premium Calibration to ISO17025 and ANSI/NCSL Z540-1 Plus Test Data (xxxx is the Frequency Option Number)
Supporting Software	
MX280005A	Vector Modulation Analysis
MX280006A	IQ Acquisition Tool
MX280007A	Mobile Interference Hunter
MS2090A	PC Remote User Interface

For a full list of all accessories for the Field Master Pro MS2090A, please refer to the Technical Data Sheet (P/N 11410-01000).

For information on NEON MA8100A Signal Mapper including NEON tracker unit, NEON signal mapper software, and NEON command software, see Anritsu brochure MA8100A NEON Signal Mapper.

• **United States**

Anritsu Americas Sales Company

450 Century Parkway, Suite 190, Allen, TX 75013 U.S.A.
Phone: +1-800-Anritsu (1-800-267-4878)

• **Canada**

Anritsu Electronics Ltd.

700 Silver Seven Road, Suite 120, Kanata,
Ontario K2V 1C3, Canada
Phone: +1-613-591-2003
Fax: +1-613-591-1006

• **Brazil**

Anritsu Eletronica Ltda.

Praça Amadeu Amaral, 27 - 1 Andar
01327-010 - Bela Vista - Sao Paulo - SP, Brazil
Phone: +55-11-3283-2511
Fax: +55-11-3288-6940

• **Mexico**

Anritsu Company, S.A. de C.V.

Bldv Miguel de Cervantes Saavedra #169 Piso 1, Col. Granada
Mexico, Ciudad de Mexico, 11520, MEXICO
Phone: +52-55-4169-7104

• **United Kingdom**

Anritsu EMEA Ltd.

200 Capability Green, Luton, Bedfordshire, LU1 3LU, U.K.
Phone: +44-1582-433200
Fax: +44-1582-731303

• **France**

Anritsu S.A.

12 avenue du Québec, Immeuble Goyave,
91140 VILLEBON SUR YVETTE, France
Phone: +33-1-60-92-15-50

• **Germany**

Anritsu GmbH

Nemetschek Haus, Konrad-Zuse-Platz 1,
81829 München, Germany
Phone: +49-89-442308-0
Fax: +49-89-442308-55

• **Italy**

Anritsu S.r.l.

Spaces Eur Arte, Viale dell'Arte 25, 00144 Roma, Italy
Phone: +39-6-509-9711

• **Sweden**

Anritsu AB

Kistagången 20 B, 2 tr, 164 40 Kista, Sweden
Phone: +46-8-534-707-00

• **Finland**

Anritsu AB

Technopolis Aviapolis, Teknobulevardi 3-5 (D208.5.),
FI-01530 Vantaa, Finland
Phone: +358-20-741-8100

• **Denmark**

Anritsu A/S

c/o Regus Winghouse, Ørestads Boulevard 73, 4th floor,
2300 Copenhagen S, Denmark
Phone: +45-7211-2200

• **Russia**

Anritsu EMEA Ltd.

Representation Office in Russia

Tverskaya str. 16/2, bld. 1, 7th floor., Moscow, 125009, Russia
Phone: +7-495-363-1694
Fax: +7-495-935-8962

• **Spain**

Anritsu EMEA Ltd.

Representation Office in Spain

Paseo de la Castellana, 141. Planta 5, Edificio Cuzco IV
28046, Madrid, Spain
Phone: +34-91-572-6761

• **Austria**

Anritsu EMEA GmbH

Am Belvedere 10, A-1100 Vienna, Austria
Phone: +43-(0)1-717-28-710

• **United Arab Emirates**

Anritsu EMEA Ltd.

Anritsu A/S

Office No. 164, Building 17, Dubai Internet City
P. O. Box - 501901, Dubai, United Arab Emirates
Phone: +971-4-3758479

• **India**

Anritsu India Private Limited

6th Floor, Indique ETA, No.38/4, Adjacent to EMC2,
Doddanekundi, Outer Ring Road, Bengaluru - 560048, India
Phone: +91-80-6728-1300
Fax: +91-80-6728-1301

• **Singapore**

Anritsu Pte. Ltd.

11 Chang Charn Road, #04-01, Shriro House, Singapore 159640
Phone: +65-6282-2400
Fax: +65-6282-2533

• **Vietnam**

Anritsu Company Limited

16th Floor, Peakview Tower, 36 Hoang Cau Street, O Cho Dua Ward,
Dong Da District, Hanoi, Vietnam
Phone: +84-24-3201-2730

• **P.R. China (Shanghai)**

Anritsu (China) Co., Ltd.

Room 2701-2705, Tower A, New Caohejing International
Business Center No. 391 Gui Ping Road Shanghai, 200233, P.R. China
Phone: +86-21-6237-0898
Fax: +86-21-6237-0899

• **P.R. China (Hong Kong)**

Anritsu Company Ltd.

Unit 1006-7, 10/F., Greenfield Tower, Concordia Plaza,
No. 1 Science Museum Road, Tsim Sha Tsui East,
Kowloon, Hong Kong, P.R. China
Phone: +852-2301-4980
Fax: +852-2301-3545

• **Japan**

Anritsu Corporation

8-5, Tamura-cho, Atsugi-shi, Kanagawa, 243-0016 Japan
Phone: +81-46-296-6509
Fax: +81-46-225-8352

• **Korea**

Anritsu Corporation, Ltd.

5FL, 235 Pangyojeok-ro, Bundang-gu, Seongnam-si,
Gyeonggi-do, 13494 Korea
Phone: +82-31-696-7750
Fax: +82-31-696-7751

• **Australia**

Anritsu Pty. Ltd.

Unit 20, 21-35 Ricketts Road, Mount Waverley, Victoria 3149, Australia
Phone: +61-3-9558-8177
Fax: +61-3-9558-8255

• **Taiwan**

Anritsu Company Inc.

7F, No. 316, Sec. 1, NeiHu Rd., Taipei 114, Taiwan
Phone: +886-2-8751-1816
Fax: +886-2-8751-1817

List Revision Date: 20210610



Anritsu utilizes recycled paper and environmentally conscious inks and toner.



© Anritsu All trademarks are registered trademarks of their respective owners. Data subject to change without notice. For the most recent specifications visit: www.anritsu.com

11410-01103, Rev. R Printed in United States 2021-11
©2021 Anritsu Company. All Rights Reserved.