

# Cobalt Series: 9 GHz



COPPER MOUNTAIN®  
TECHNOLOGIES



- **Frequency range:** 100kHz - 9 GHz
- **Wide output power range:** -60 dBm to +15 dBm
- **Dynamic range:** 152 dB (10 Hz IF bandwidth) typ.
- **Measurement time per point:** 10  $\mu$ s per point, min typ.
- **16 logical channels with 16 traces** each max.
- **Automation programming** in LabVIEW, Python, MATLAB, .NET, etc.
- 2- and 4-port models with **Direct Receiver Access** and **Frequency Extension** as available options
- **Time domain and gating** conversion included
- **Fixture simulation**
- **Frequency offset mode**, including vector mixer calibration measurements
- Up to **500,001 measurement points**
- Multiple **precision calibration** methods and automatic calibration

# Cobalt Series: 9 GHz



The Cobalt 9 GHz Product Series of high-performance vector network analyzers offers an unmatched price-performance combination for S-parameter measurement between 100 kHz and 9 GHz and incorporates multiple technological innovations.

Advanced electromagnetic modeling was used to optimize the 9 GHz Cobalt's ultra-wideband directional coupler design. Because we incorporated new production methods for precision, these directional couplers have extraordinary stability, both over temperature and over very long intervals of time. Cobalt's hybrid dual-core DSP+FPGA signal processing engine, combined with new frequency synthesizer technologies, propel Cobalt's measurement speed to among the most advanced instruments in the industry, and well past the achievements of any cost-competitive products.

Copper Mountain Technologies' USB VNAs are next generation analyzers designed to meet the needs of 21st Century engineers. Our VNAs include an RF measurement module

and a processing module, a software application which runs on a Windows or Linux PC, laptop, or tablet, connecting to the measurement hardware via USB interface.

This innovative approach delivers high measurement accuracy and enables users to take advantage of faster processors, newer computers and larger displays. USB VNAs have lower Total Cost of Ownership and fewer potential failure points.

These instruments are smaller and lighter, can go almost anywhere, are very easy to share and eliminate the need for data purging or hard drive removal in secure environments.

# The Whole Solution

## Warranty, Service & Repairs

All our products come with a standard three-year warranty from date of shipment. During that time we will repair or replace any product malfunctioning due to defective parts or labor.

While we pride ourselves on quality of our instruments, should your VNA malfunction for any reason, we will gladly offer a loaner unit while we service yours. With our USB VNAs where all data is stored on your PC, a simple swap of the measurement module assures uninterrupted workflow and little or no downtime.

## Our Engineers are an Extension of Your Team

Our team of applications engineers, service technicians, and metrology scientists are here to help you with technical support, application-specific recommendations, annual performance testing, and troubleshooting or repair of your CMT instruments.

Our engineers will work with your team to augment your in-house capabilities. We can write custom applications and test software, develop test automation scripts and help with integrated RF system testing. We can design and provide an RF switching network specific to your requirements; electro-mechanical, solid-state, or PIN diode-based. If the S-parameter measurement fixture involves challenging conditions for repeatability and accuracy we can assist with measurement uncertainty analysis.

An extensive library of technical materials including application notes, tips on performing VNA measurements, sample automation scripts, and how-to videos are available on our website [www.coppermountaintech.com](http://www.coppermountaintech.com) and YouTube channel, CopperMountainTech.

## Annual Calibration

Copper Mountain Technologies' Indianapolis calibration laboratory is accredited in accordance with the recognized international standard ISO/IEC 17025:2017 and meets the requirements of ANSI/NCSL Z540-1994-1. All reference standards and equipment in the laboratory are traceable to National Institute of Standards and Technology (NIST) or international equivalent.

Should you prefer to perform the annual testing yourself or use a third party, contact us for information or questions on performing these procedures. Additionally, the VNA Performance Test (VNAPT) software application is available for third party laboratories without restriction. Use of VNAPT to execute performance tests is optional, but the software is designed to automate and streamline VNA performance testing, including automatic generation of test reports. Please contact Copper Mountain Technologies or your local distributor for recommended calibration options.

**“The small size and low weight of CMT’s VNAs are also advantageous for applications in the manufacturing industries. For example, applications such as base transceiver station (BTS) filter tuning or semiconductor manufacturing require a wide dynamic range and fast speed. CMT’s C1209 and C1220 are ideal instruments for these applications because they not only address the performance requirements of the applications but their form factor also enables them to be put on top of the handlers rather than being put on the side, where they take up space.”**

– *Jessy Cavazos | Industry Director, Frost & Sullivan*



# Software Application

## Software application is part of the VNA

The software application takes raw measurement data from the data acquisition (measurement) module and recalculates into S-parameters in multiple presentation formats utilizing proprietary algorithms. These new and advanced calibration and other accuracy enhancing algorithms were developed by our metrology experts. Our software can be downloaded free from our website, used on an unlimited number of PCs using either Linux or Windows operating systems, and enables easy VNA integration with other software applications and automation.

The software application features a fully functioning Demo Mode, which can be used for exploring the VNAs' features and capabilities without an actual measurement module connected to your PC.

## Measurement Capabilities

### Measured parameters

S11, S21, S12, S22 for the 2-port models and S11...S44 for the 4-port models, and absolute power of reference and received signals at the port.

### Number of measurement channels

Up to 16 independent logical channels: each logical channel is represented on the screen as an individual channel window. A logical channel is defined by such stimulus signal settings as frequency range, number of test points, or power level.

### Data traces

Up to 16 data traces can be displayed in each channel window. A data trace represents one of the DUT parameters, including S-parameters, response in time domain, or input power response.



### Memory traces

Each of the 16 data traces can be saved into memory for further comparison with the current values.

### Data display formats

Logarithmic magnitude, linear magnitude, phase, expanded phase, group delay, SWR, real part, imaginary part, Smith chart diagram and polar diagram display formats are available.

## Dynamic Range & Speed

Cobalt's combination of a wide dynamic range and high measurement speed make it an ideal VNA for measuring and tuning high performance filters.

## BTS Filter Tuning

Cobalt VNAs have more than 152 dB dynamic range at 10 Hz IFBW, which allows them to maintain a wide measurement range at high measurement speeds. Measurement of all S-parameters of a BTS filter with full two-port and 801 measurement points with 1 MHz IFBW takes only 17.5ms while maintaining a measurement range of over 100 dB. This time is almost completely determined by the IFBW of the VNA. This measurement speed allows for real time tuning of high isolation BTS filters.

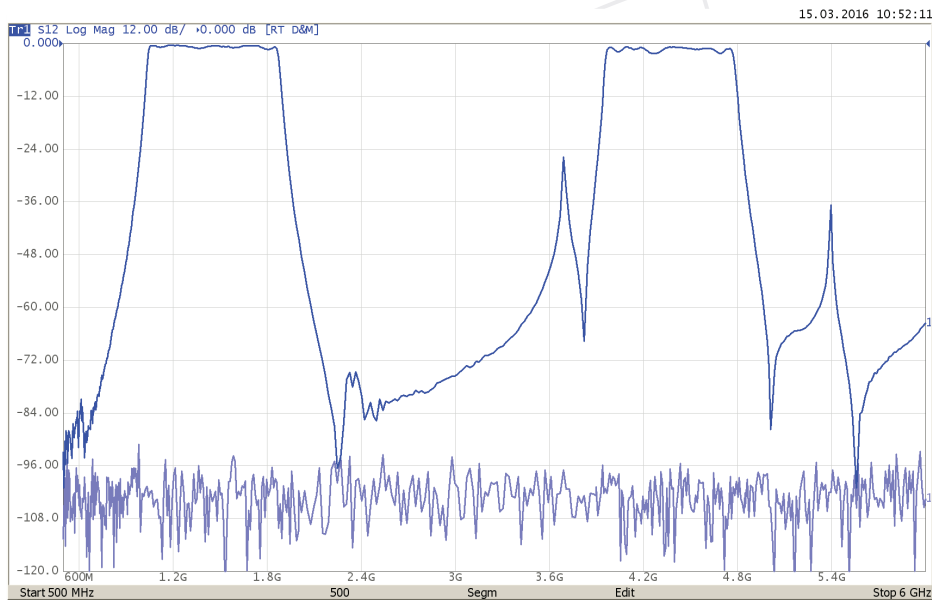
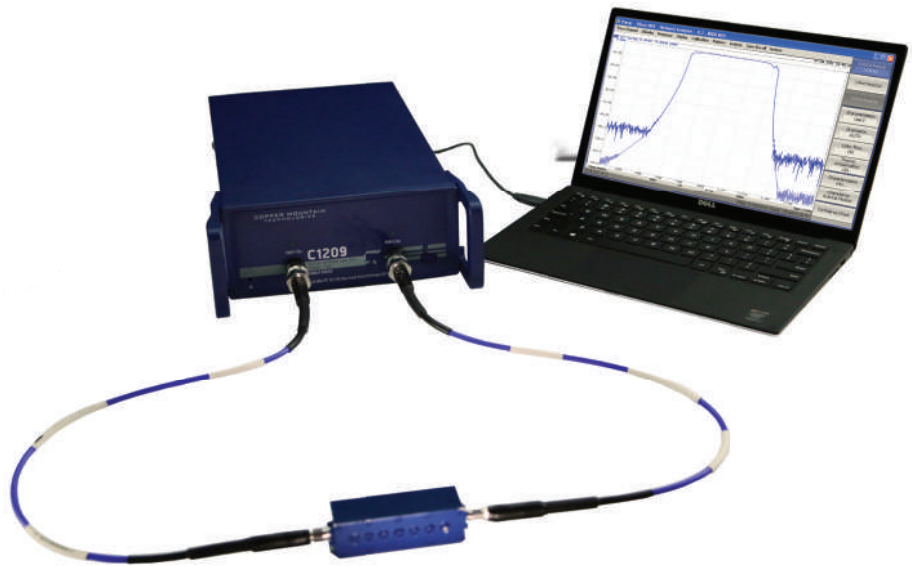

## SAW Filters

The 152 dB dynamic range of Cobalt VNAs combined with high measurement speed per point allows measurement of SAW filters' S-parameters with full 2-port calibration and 1601 measurement points in less than 32 ms while still maintaining more than 100 dB measurement range (IFBW at 1 MHz). This measurement speed corresponds to the performance of the most advanced handlers used for automatic verification of mass-produced SAW filters.

# Software Application



## Sweep Features

### Sweep type

Linear frequency sweep and logarithmic frequency sweep are performed with fixed output power. Linear power sweep is a fixed frequency.

### Measured points per sweep

Set by the user from 2 to at least 500,001.

### Segment sweep features

A frequency sweep within several independent user-defined segments. Frequency range, number of sweep points, source power, and IF bandwidth can be set for each segment.

### Output Power

Source power from -60 dBm to +15 dBm with a resolution of 0.05 dB. In frequency sweep mode power slope can be set up to 2 dB/GHz to compensate for high frequency attenuation in fixture cables.

### Sweep Trigger

*Trigger modes:* continuous, single, or hold.

*Trigger sources:* internal, manual, external, bus.

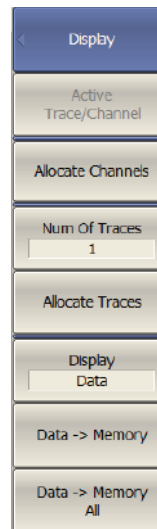

## Trace Functions

### Trace display

Data trace, memory trace, or simultaneous indication of data and memory traces.

### Trace math

Data trace modification by math operations: addition, subtraction, multiplication or division of measured complex values and memory data.

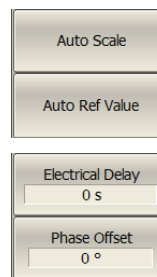

### Autoscaling

Automatic selection of scale division and reference level value to have the trace most effectively displayed.

### Electrical delay

Calibration plane moving to compensate for the delay in the test setup, or for compensation of electrical delay in the device under test (DUT) during measurements phase deviation.

### Phase offset

Defined in degrees.

# Frequency Scan Segmentation

The VNA has a large frequency range with the option of frequency scan segmentation. This allows for optimal use of the instrument to realize maximum dynamic range while maintaining high measurement speed.

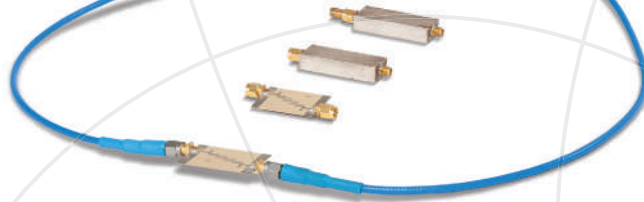
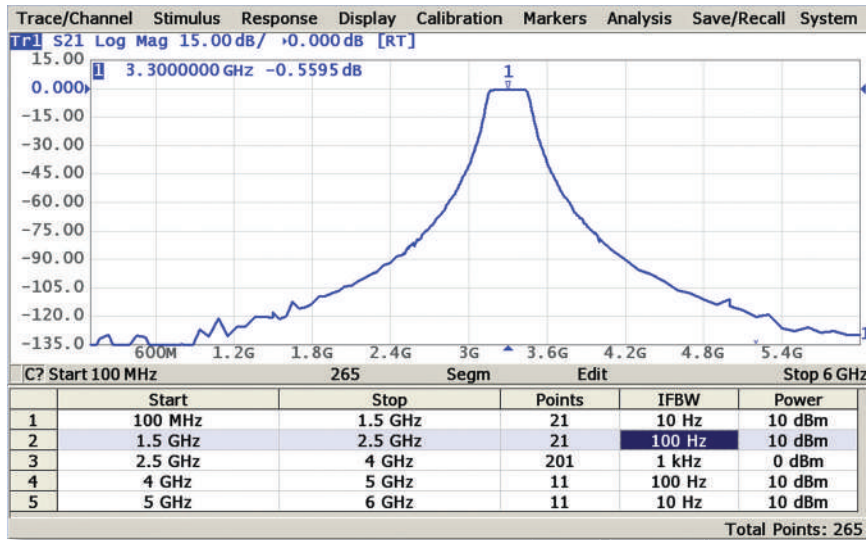

# Software Application

## Power Scaling & Compression Point Recognition

The power sweep feature turns compression point recognition, one of the most fundamental and complex amplifier measurements, into a simple and accurate operation.

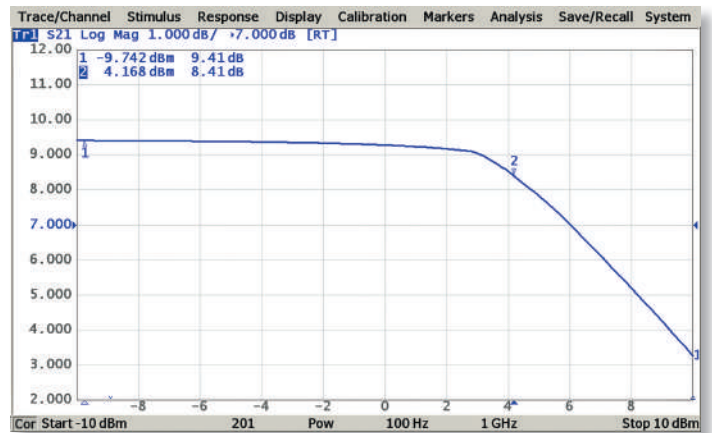
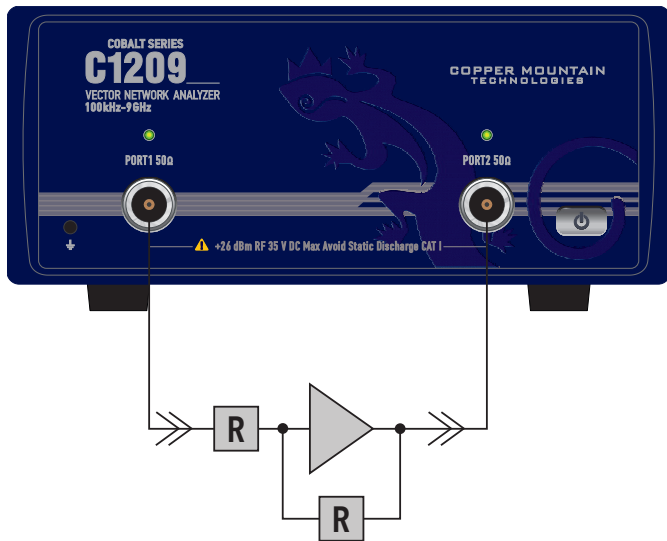



### Scalar mixer/converter measurements

The scalar method allows the user to measure only the magnitude of the transmission coefficient of the mixer or other frequency translating device. No external mixers or other devices are required. The scalar method employs port frequency offset when there is a difference between the source port frequency and the receiver port frequency.

### Scalar mixer/converter calibration

This is the most accurate method of calibration applied for measurements of mixers in frequency offset mode. The OPEN, SHORT, and LOAD calibration standards are used. An external power meter should be connected to the USB port directly or via USB/GPIB adapter.

### Vector mixer/converter measurements

The vector method allows measurement of both the magnitude and phase of the mixer transmission coefficient. This method requires an external mixer and an LO common to both the external mixer and the mixer under test.

### Vector mixer/converter calibration

This method of calibration is applied for vector mixer measurements. OPEN, SHORT, and LOAD calibration standards are used.

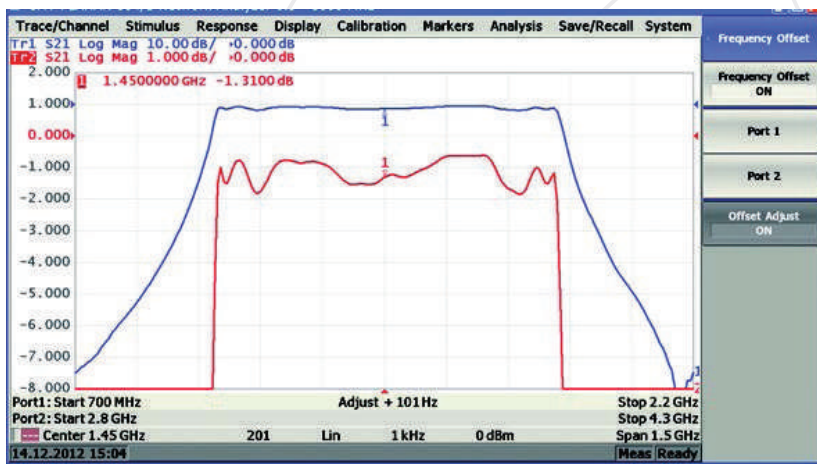
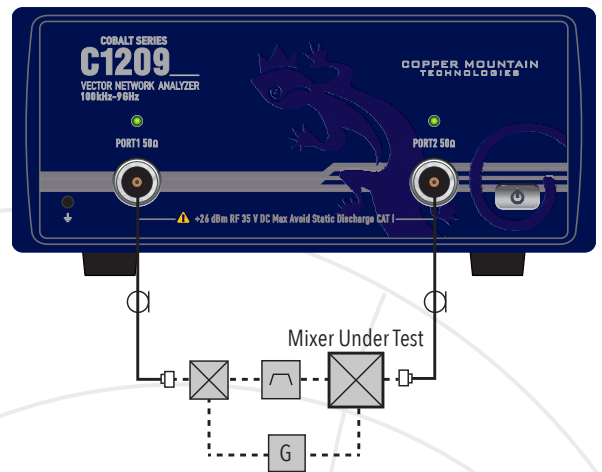
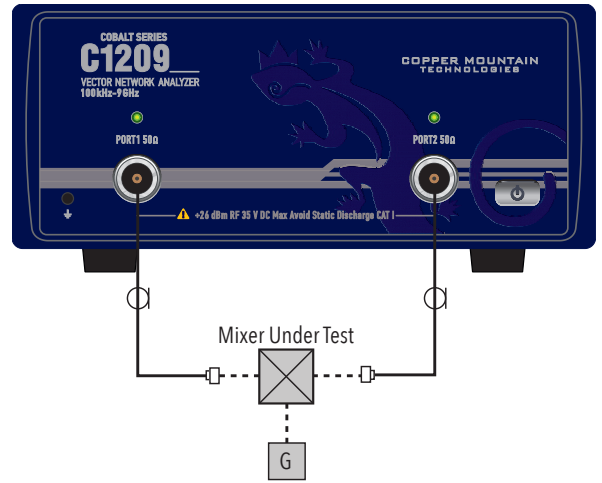

### Automatic frequency offset adjustment

This function performs automatic frequency offset adjustment when the scalar mixer/converter measurements are performed to compensate for LO setting inaccuracy of the DUT.

# Software Application

## Time Domain Measurements

This function performs conversion from frequency domain into response of the DUT to various stimulus types in time domain. Modeled stimulus types are bandpass, lowpass impulse, and lowpass step. The time domain span is arbitrarily between zero to maximum, which is determined by the frequency step. Windows of various shapes are used for tradeoff between resolution and levels of spurious sidelobes.

Here, built in time domain analysis allows the user to detect a physical impairment in a cable.

Time domain analysis allows measurements of SAW filters such as the time delay and feedthrough signal suppression.

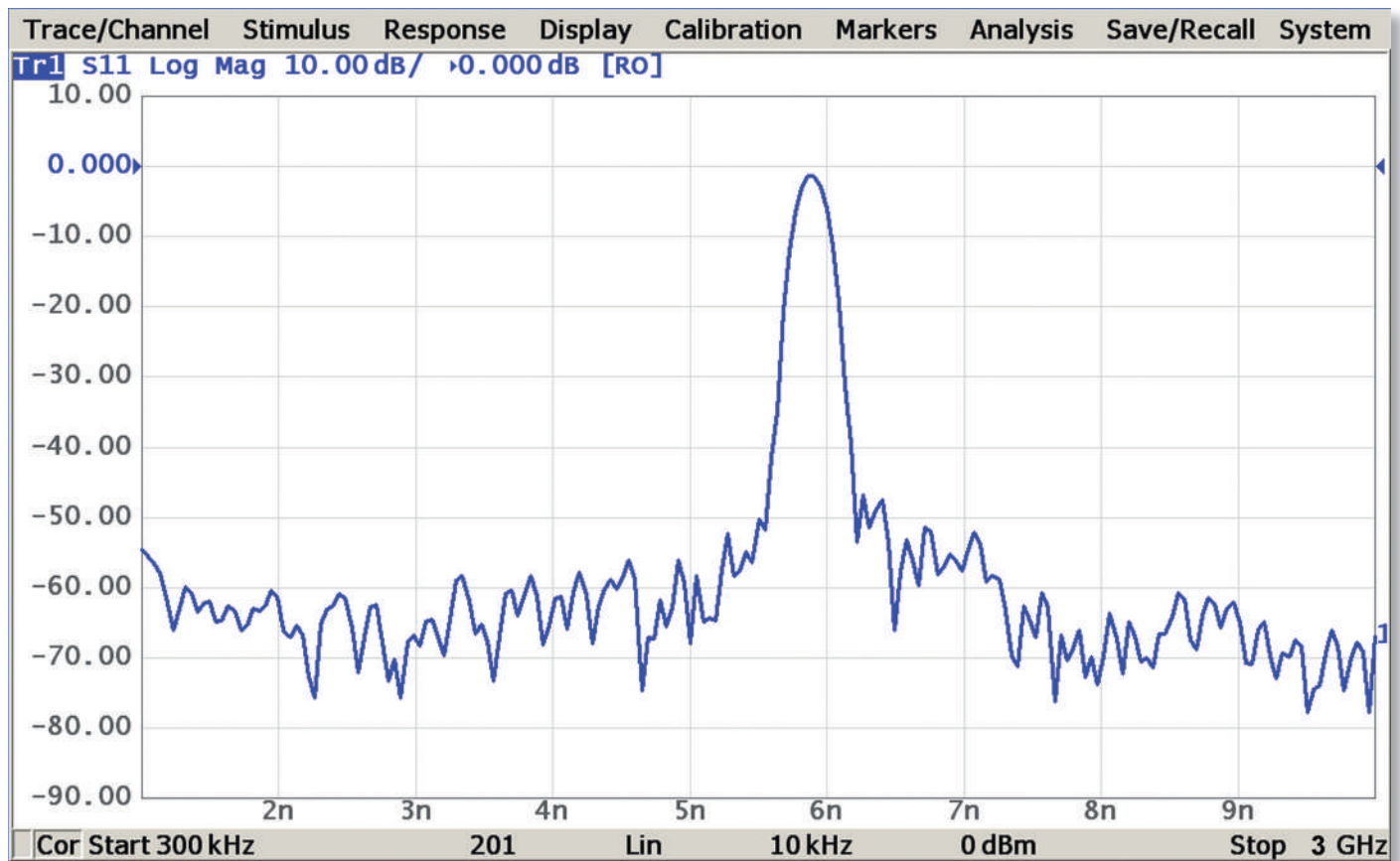

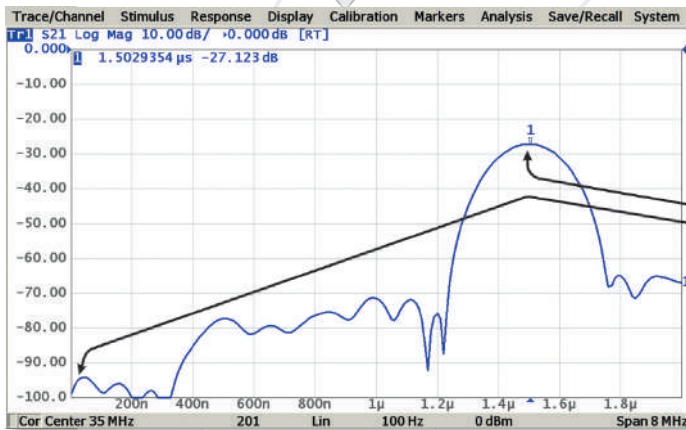
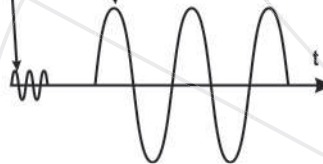
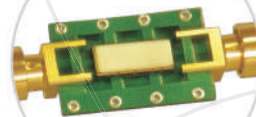
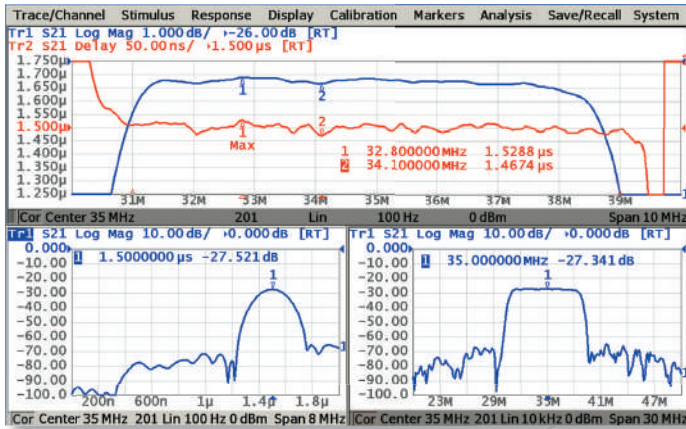

# Software Application

## Time Domain Gating

This function mathematically removes unwanted responses in the time domain, which allows the user to obtain a frequency response without effects of fixture elements.

This function applies reverse transformation back to the frequency domain after cutting out the user-defined span in the time domain. Gating filter types are bandpass or notch. For a better tradeoff between gate resolution and level of spurious sidelobes the following filter shapes are available: maximum, wide, normal and minimum.

Applications of these features include, but are not limited to: measurements of SAW filter parameters, such as filter time delay or forward transmission attenuation.

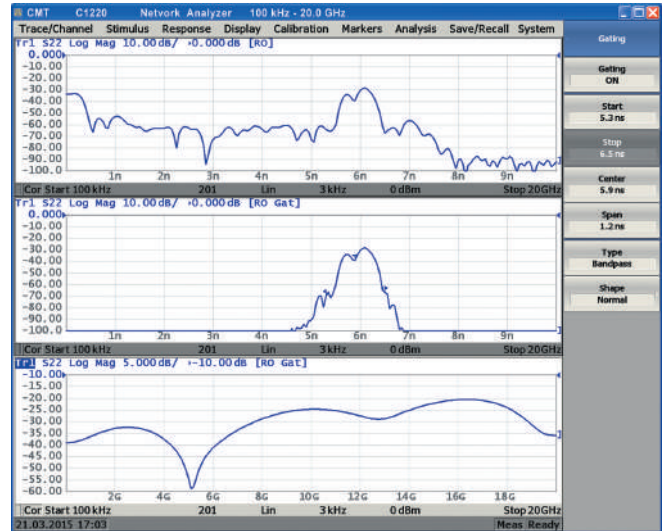

## Limit Testing

Limit testing is a function for automatic pass/fail based on measurement results. Pass/fail is based on comparison of the trace to the limit line set by the user and can consist of one or several segments.

Each segment checks the measurement value for failing either the upper or lower limit, or both. The limit line segment is defined by specifying the coordinates of the beginning (X0, Y0) and the end (X1, Y1) of the segment, and type of the limit. The MAX or MIN limit types check if the trace falls outside of the upper or lower limit, respectively.

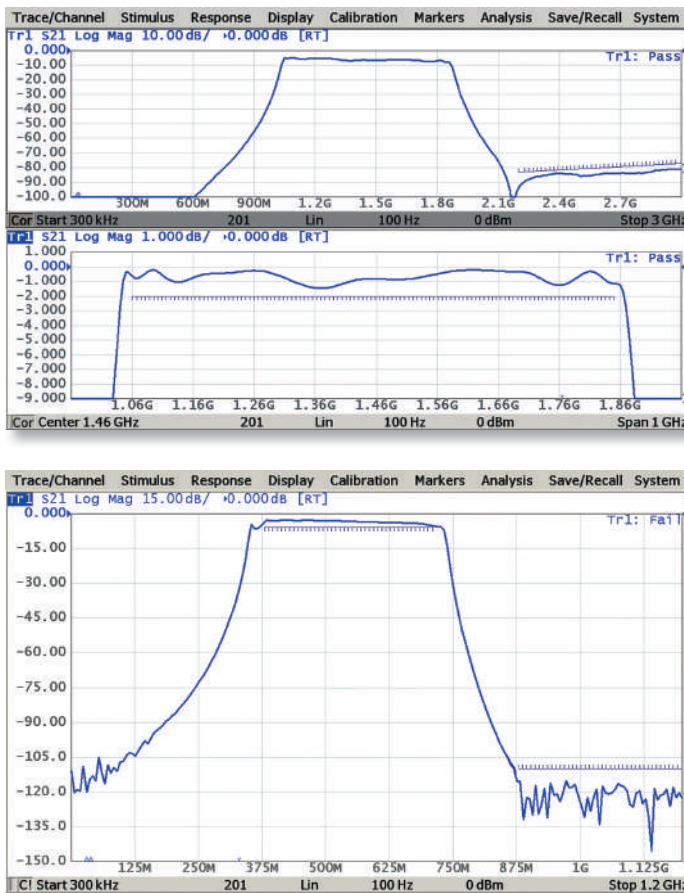

# Cobalt Series: 9 GHz

## Embedding

Allows the user to mathematically simulate the DUT parameters after virtual connection through a fixture circuit between the calibration plane and the DUT. This circuit is described by an S-parameter matrix in a Touchstone file.

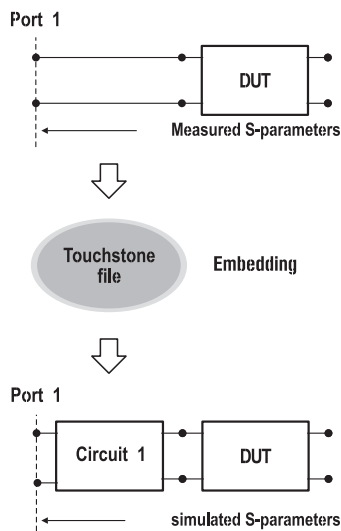

## De-Embedding

Allows users to mathematically exclude from the measurement result the effect of the fixture circuit connected between the calibration plane and a DUT. This circuit should be described by an S-parameter matrix in a Touchstone file.

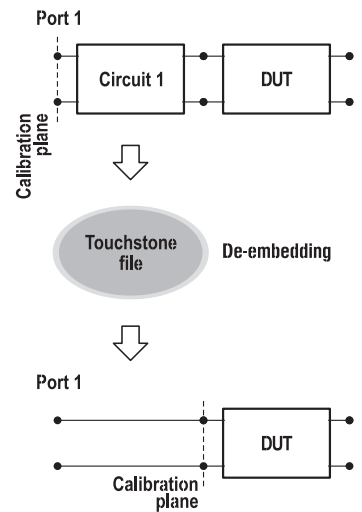

## AUX Ports (Optional)

Some measurement applications, for example characterization of a log amplifier, involve measurement of the detector's output voltage or an amplifier DUT's efficiency over frequency or input power, which necessitates making voltage measurements in addition to standard S-parameter measurements. Cobalt series analyzers configured with option HW-C-AUX incorporate two general-purpose analog voltage input ports to measure system or DUT voltages synchronously with the VNA sweep. Either input may be configured for +/- 1.0 VDC or +/- 10.0 VDC operation and voltage measurements viewed directly in the VNA's Windows application.

# Software Application

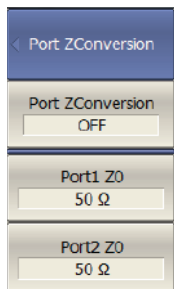

## Port Impedance Conversion

This function converts the S-parameters measured at a 50 Ω port into values which would be seen if measured at a test port with arbitrary impedance.

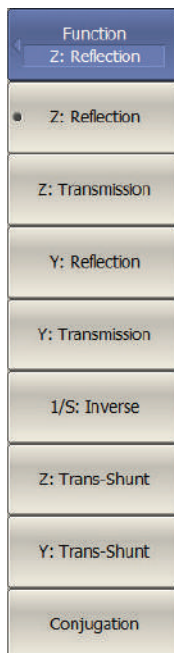

## S-Parameter Conversion

This function allows for conversion of measured S-parameters to the following parameters: reflection impedance and admittance, transmission impedance and admittance, and inverse S-parameters.

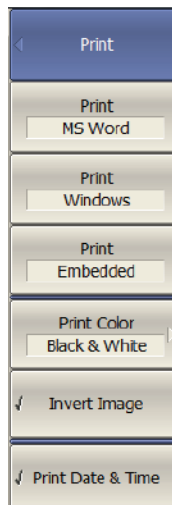
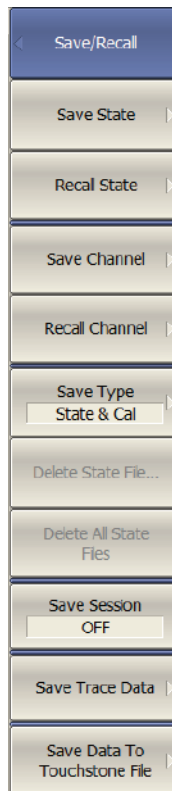

## Data Output

**Analyzer State** All state, calibration and measurement data can be saved to an Analyzer state file on the hard disk and later recalled into the software program. The following four types of states are available: State, State & Cal, Stat & Trace, or All.

**Channel State** A channel state can be saved into the Analyzer state. The procedure is similar to saving of the Analyzer state, and the same types are applied to channel saving. Unlike Analyzer state, channel state is saved into the Analyzer volatile memory (not to the hard disk) and is cleared when power to the Analyzer is switched off. For channel state, there are four memory registers A, B, C, D. Channel state saving allows the user to easily copy the settings of one channel to another one.

**Trace Data CSV File** The Analyzer allows the user to save an individual trace's data as a CSV file (comma separated values). The active trace stimulus and response values, in its current format are saved to a \*.CSV file.

**Trace Data Touchstone File** Allows the user to save S-parameters to a Touchstone file. The Touchstone file contains frequency values and S-parameters. Files of this format are industry-standard for most circuit simulator programs. The .s2p, .s3p, and .s4p files are used for saving all S-parameters of a device. The .s1p files are used for saving S11 or S22 parameters of a 1-port device. The Touchstone file saving function is applied to individual channels.

**Screenshot capture** A print function is provided with a preview feature, which allows for viewing the image to be printed on the screen, and/or save it to a file. Screenshots can be printed using three different applications: MS Word, Image Viewer for Windows, or the Print Wizard of the Analyzer. Each screenshot can be printed in color, grayscale, black and white, or inverted for visibility or to save ink. The current date and time can be added to each capture before it is transferred to the printing application, resulting in quick and easy test reporting.

# Calibration

## User Calibration

Calibration of a test setup (which includes the VNA, cables, and adapters) significantly increases the accuracy of measurements. Calibration allows for correction of errors caused by imperfections in the measurement system: system directivity, source and load match, tracking, and isolation.

### Calibration methods

The following calibration methods of various sophistication and accuracy are available:

- Reflection & transmission normalization
- Full one-port calibration
- One-path two-port calibration
- Full two-port, three-port and four-port calibration

### Reflection and transmission normalization

This is the simplest calibration method; however, it provides reduced accuracy compared to other methods.

### Full one-port calibration

Method of calibration performed for one-port reflection measurements. It ensures high accuracy.

### One-path two-port calibration

Method of calibration performed for reflection and one-way transmission measurements, for example for measuring S11 and S21 only. It ensures high accuracy for reflection measurements, and moderate accuracy for transmission measurements.

### Full two-port, three-port, four-port calibration

This method of calibration is performed for full S-parameter matrix measurement of a two-port DUT, ensuring high accuracy.

### TRL calibration

Method of calibration performed for full S-parameter matrix measurement of a two-port, three-port, or four-port DUT. It ensures higher accuracy than two-port calibration. LRL and LRM modifications of this calibration method are available.

## Mechanical Calibration Kits

The user can select one of the predefined calibration kits of various manufacturers or define a new calibration kit.

### Electronic Calibration Modules

Electronic, or automatic, calibration modules offered by CMT make calibration faster and easier than traditional mechanical calibration.

### Sliding load calibration standard

The use of a sliding load calibration standard allows for a significant increase in calibration accuracy at high frequencies compared to the fixed load calibration standard.

### “Unknown” thru calibration standard

The use of a generic two-port reciprocal circuit instead of a characterized Thru in full two-port calibration allows the user to calibrate the VNA for measurement of “non-insertable” devices.

### Defining of calibration standards

Different methods of calibration standard definition are available: standard definition by polynomial model and standard definition by data (S-parameters).

### Error correction interpolation

When the user changes any settings such as the start/stop frequencies or the number of sweep points, compared to the settings at the moment of calibration, interpolation or extrapolation of the calibration coefficients will be applied.

### Power calibration

Power calibration allows more stable power level setting at the DUT input. An external power meter should be connected to the USB port directly or via a USB/GPIB adapter.

### Receiver calibration

This method calibrates the receiver gain at the absolute signal power measurement.

# Automation

## Automation Languages

We maintain code examples and guides in the following languages:

- Python \*
- C++\*
- LabVIEW
- VBA
- MATLAB
- And many more

*\*Available for use with Linux operating system*

## Measurement Automation

**COM/DCOM interface** The VNA software provides a COM/DCOM (ActiveX) interface, allowing the instrument to be used as a part of a larger test system and in other specialized applications. The VNA program runs as a COM/DCOM server, while the user program runs as a client. COM/DCOM is able to be used with Windows OS only.

**SCPI via TCP Socket** Alternatively a TCP socket is provided for automation from either localhost--the same machine running the VNA software application--or from a second PC connected by an IP network. The SCPI command is largely compatible with legacy instruments, maximizing code reuse for existing test automation platforms. SCPI via TCP Socket is able to be used with either Windows or Linux operating systems.

**SCPI via HiSlip** Based on VXI-11, the HiSlip interface uses the same SCPI command set but further allows for instrument discovery and provides ease of automation through Visa library of your choice. SCPI via HiSlip is able to be used with either Windows or Linux operating systems.

**LabVIEW compatible** The device and its software are fully compatible with LabVIEW applications, for ultimate flexibility in user-generated programming and automation. LabVIEW is able to be used with Windows OS only.

Our command set is modeled after industry-standard legacy equipment; porting code is straightforward and we can help. Complete installation of any CMT software comes with multiple programming examples and guides installed in the C:\VNA\S2VNA\ or C:\VNA\S4VNA\ Programming Examples and Guides



directory on Windows or ~/Documents/VNA directory on Linux.

CMT software includes many features that other vendors offer as options, including Time Domain capability, S-parameter Embedding and De-Embedding, Frequency Offset, and Vector Mixer Calibration functionality. No integrated PC means faster data processing turnaround and regular updates that are easy to install. Less complexity in the VNA leads to fewer points of failure that cost you production/development time.

Software comes with all the features developers have come to expect: segmented frequency sweeps, linear/logarithmic sweeps, power sweeps, multiple trace formats, 16 channels max. with up to 16 traces each, marker math, and limit tests. These provide added value to production testing by simplifying measurement interpretation. Plugins can add wide ranges of functionality and can be developed upon request. Examples include streamlined production applications, functionality to trigger with external generators, and virtual circuit matching modeling.

## Automation Features

- Segmented frequency sweeps
- Linear/logarithmic sweeps
- Power sweeps
- Multiple trace formats
- 16 channels max. with up to 16 traces each
- Marker math
- Limit tests



# CobaltFx Frequency Extender System



CobaltFx is a new millimeter-wave frequency extension solution, the first that can be anchored by a 9 GHz or a 10 GHz VNA. CobaltFx series allows engineers to build a scalable and affordable 5G testing solution. Each frequency band can be incorporated into the CobaltFx solution as needed, allowing for an easy expansion of the range of 5G components and products tested in development and production and smaller upfront investment. This cost-effective millimeter wave frequency extension system offers industry leading range and sweep speeds.

CobaltFx's high dynamic range and directivity allow for highly accurate and stable millimeter-wave S-parameter measurements in four dedicated frequency bands:

- 18-54 GHz (coaxial)
- 50-75 GHz (waveguide)
- 60-90 GHz (waveguide)
- 75-110 (waveguide)

CobaltFx offers an unparalleled combination of price, performance, flexibility and size. The VNAs used in this system are from Copper Mountain Technologies' USB industry leading Cobalt Series. They feature fast sweep speeds down to 0.2 microseconds per point and a dynamic range of up to 152 dB, all comprised in a compact, USB form factor. FEV frequency extension modules are developed in collaboration with Farran

Technology, a globally recognized brand in millimeter-wave development.

Copper Mountain Technologies' USB VNAs are next generation analyzers designed to meet the needs of 21st Century engineers. Our VNAs include an RF measurement module and a processing module, a software application which runs on a Windows or Linux PC, laptop, or tablet, connecting the measurement hardware via USB interface.

This innovative approach delivers high measurement accuracy and enables users to take advantage of faster processors, newer computers and larger displays. USB VNAs have lower Total Cost of Ownership and fewer potential failure points. These instruments are smaller and lighter, can go almost anywhere, are very easy to share and eliminate the need for data purging or hard drive removal in secure environments.

Visit [www.coppermountaintech.com](http://www.coppermountaintech.com) or [www.farran.com](http://www.farran.com) for more information.

# Software Plug-ins/Manufacturing Plug-in

All Copper Mountain Technologies VNAs include support for executable software add-on modules or plug-ins. With plug-ins, customers and CMT support engineers can develop extensions to the base software launched from inside the main application menu. Place your executable into the /Plug-ins/ subfolder of your VNA's installation path, and then use the System->Plug-ins menu sequence to launch.

Most plug-ins are developed based on specific customer's needs. We also offer source code for many plug-ins to help you get started with creating your own plug-ins or as a jumping off point for automation projects.

## Manufacturing Plug-in

Our most popular plug-in, Manufacturing Test, supports incorporating VNA software into your manufacturing QMS:

- Streamline production test processes.
- Ensure consistency of test process across multiple operators and workstations.
- Easily create and manage pass/fail limits across multiple workstations. Pass/fail limits and instrument configuration are stored in a human-readable plaintext "specifications" file which can be maintained by an authorized test engineer.
- Organize test results for subsequent retrieval and analysis.

With CMT's manufacturing test plug-in, production managers can meet these requirements and assure the same test settings and process are applied consistently at all times. Photographs of the calibration and test process are displayed during setup to prompt the operator through each process step. After each test, results are automatically archived into a network folder for reporting and analysis. The test plug-in also allows for hard copies of the test result to be automatically printed at the time of test, so the result can be included with the product when it ships to the end customer.

Test settings for each product are updated by the production manager based on similar products or a generic "template" which can be readily customized.

The image displays two screenshots of the Copper Mountain Technologies software interface. The left screenshot shows the 'RETURN LOSS' configuration screen. It features a large '50 OHM' display, a list of status indicators (SPECIFICATION LOADED, VNA CONFIGURED, VNA CALIBRATED, LOT OPENED), and a form for entering test parameters: ITEM NUMBER (EXAMPLE RETURN LOSS), LOT NUMBER (001), OPERATOR (John), and PUT UP MACHINE (001). A prominent orange 'OPEN LOT' button is at the bottom. The right screenshot shows the 'Ready to Test the Next Coax' screen. It features a large green 'PASS' indicator at the top right. Below it, there are input fields for REEL NUMBER (1) and NOW TESTING COAX (2). A large blue 'TEST' button is in the center. Below the button, there are two progress indicators: 'TESTS PASSED 100%' (TOTAL TESTED: 1, PASSED: 1, FAILED: 0) and 'RETESTS PASSED ---%' (TOTAL RETESTED: 0, PASSED: 0, FAILED: 0). At the bottom, there are buttons for 'PRINT VNA SCREENSHOT', 'CHANGE OPERATOR', and 'CLOSE LOT'. The status bar at the bottom of both screenshots shows system information like date, time, and version.

# Automatic Fixture Removal Plug-in

Automatic Fixture Removal (AFR) VNA software plug-in enables the measurement of a wide range of components through comprehensive methods tailored to specific fixture properties. The intuitive AFR software moves the calibration plane towards hard to access DUTs and guides the de-embedding process using either time-gating, filtering, or bisect methods. These methods provide the user with better measurement accuracy and reliability based on the components to test. The AFR software plug-in is easy to use and is compatible with all CMT Cobalt series VNAs and Compact series two-port, two-path VNAs.

The Automatic Fixture Removal (AFR) plugin uses metrology grade de-embedding algorithms to eliminate fixture effects on your DUT. CMT offers 2xThrough fixture removal support with three methods that fit different fixture configurations:

1. Time-gating approach is ideal for fixtures with long electrical length of leading transmission lines or for higher frequency options.
2. Filtering algorithm is useful in cases where signals in both parts of the fixture significantly overlap in time domain.
3. Bisect method covers instances with short electrical length of the fixture leading transmission lines and inadequate time domain resolution.

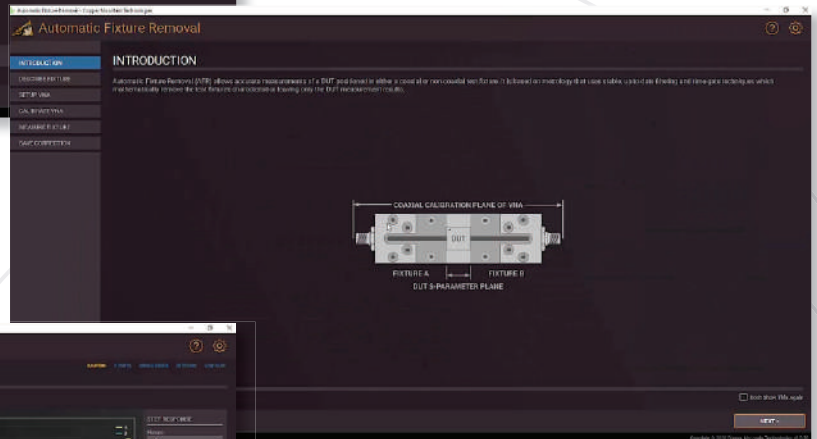
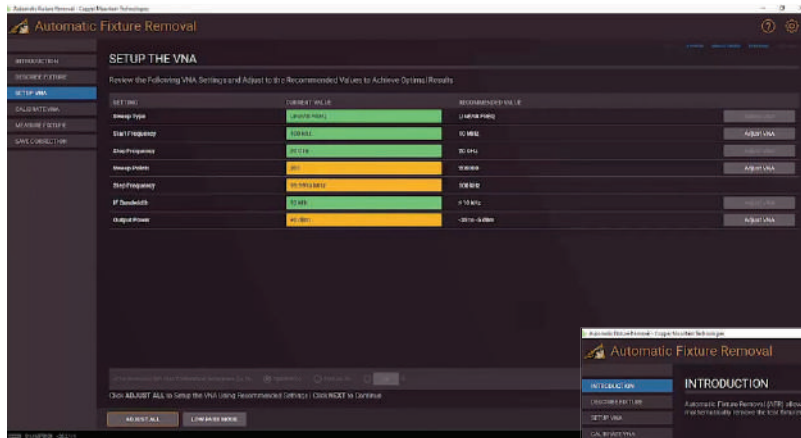

# Cobalt 9 GHz Product Series Specs<sup>1</sup>

## Measurement Accuracy<sup>3</sup>

Accuracy of transmission measurements <sup>4</sup>	Magnitude / Phase
100 kHz to 1 MHz	
5 dB to 15 dB	±0.2 dB / ±2°
-30 dB to 5 dB	±0.1 dB / ±1°
-50 dB to -30 dB	±0.2 dB / ±2°
-70 dB to -50 dB	±1.0 dB / ±6°
1 MHz to 8 GHz	
5 dB to 15 dB	±0.2 dB / ±2°
-70 dB to 5 dB	±0.1 dB / ±1°
-90 dB to -70 dB	±0.2 dB / ±2°
-110 dB to -90 dB	±1.0 dB / ±6°
8 GHz to 9 GHz	
5 dB to 15 dB	±0.2 dB / ±2°
-60 dB to 5 dB	±0.1 dB / ±1°
-80 dB to -60 dB	±0.2 dB / ±2°
-100 dB to -80 dB	±1.0 dB / ±6°
Accuracy of reflection measurements <sup>5</sup>	Magnitude / Phase
-15 dB to 0 dB	±0.4 dB / ±3°
-25 dB to -15 dB	±1.0 dB / ±6°
-35 dB to -25 dB	±3.0 dB / ±20°
Trace noise magnitude (IF bandwidth 3 kHz)	
100 kHz to 1 MHz	0.005 dB rms
1 MHz to 9 GHz	0.001 dB rms
Temperature dependence	0.02 dB/°C (0.01 dB/°C typ.)

## Effective System Data

100 kHz to 1 MHz	
Directivity	46 dB
Source match	40 dB
Load match	46 dB
Reflection tracking	±0.05 dB
Transmission tracking	±0.10 dB
1 MHz to 9 GHz	
Directivity	46 dB
Source match	40 dB
Load match	46 dB
Reflection tracking	±0.05 dB
Transmission tracking	±0.05 dB

## Test Port Output

Power range	-60 dBm to +15 dBm
Power accuracy	±1.5 dB
Power resolution	0.05 dB
Harmonic distortion <sup>6</sup>	-25 dBc
Non-harmonic spurious <sup>6</sup>	-30 dBc

## Measurement Speed

Time per point	10 µs typ.	
Port switchover time	0.2 ms typ.	
Typical cycle time vs number of measurement points		
Number of points (IF bandwidth 1 MHz)	Uncorrected	2-port calibration
51	1.0 ms	2.0 ms
201	2.6 ms	5.0 ms
401	4.6 ms	9.0 ms
1601	16.7 ms	33.3 ms

## Frequency Reference Input

Port	10 MHz Ref In
External reference frequency	10 MHz
Input level	-2 dBm to 4 dBm
Input impedance	50 Ohm
Connector type	BNC, female

## Frequency Reference Output

Port	10 MHz Ref Out
Internal reference frequency	10 MHz
Output reference signal level at 50 Ohm impedance	0 dBm to 2 dBm
Connector type	BNC, female

[1] All specifications subject to change without notice. [3] Reflection and transmission measurement accuracy applies over the temperature range of (73 ± 9)° F or (23 ± 5)° C after 40 minutes of warming-up, with less than 1° C deviation from the full two-port calibration temperature, at output power of 0 dBm. Frequency points have to be identical for measurement and calibration (no interpolation allowed). [4] Transmission specifications are based on a matched DUT, and IF bandwidth of 1 Hz. [5] Reflection specifications are based on an isolating DUT. [6] Specification applies over frequency range from 1 MHz to 9 GHz, at output power of 0 dBm.

# Cobalt 9 GHz Product Series Specs<sup>1</sup>

## Trigger Input

Port	Ext Trig In
Input level	
Low threshold voltage	0.8 V
High threshold voltage	2.7 V
Input level range	0 to + 5 V
Pulse width	≥2 μs
Polarity	positive or negative
Input impedance	≥10 kOhm
Connector type	BNC, female

## Trigger Output

Port	Ext Trig Out
Maximum output current	20 mA
Output level	
Low level voltage	0.4 V
High level voltage	3.0 V
Polarity	positive or negative
Connector type	BNC, female

## Aux Ports (Optional)

Port	AUX In1, AUX In2
DC voltage range	±1 V, or ±10 V selectable
Measurement accuracy	
±1 V input	1 % ± 1 mV
±10 V input	1 % ± 10 mV
Input impedance	≥10 kOhm
Damage voltage	30 V
Number of ports	2
Connector type	BNC, female

## Environmental Specifications

Operating temperature	+5 °C to +40 °C (41 °F to 104 °F)
Storage temperature	-50 °C to +70 °C (-58 °F to 158 °F)
Humidity	90 % at 25 °C (77 °F)
Atmospheric pressure	70.0 kPa to 106.7 kPa

## Calibration

Recommended Factory Adjustment Interval	3 Years
---	---------

# C1209 Specifications<sup>1</sup>

## Primary Specifications

Impedance	50 Ohm
Test port connector	type N, female
Number of test ports	2 ports
Direct Access (Source, Ref, and Meas)	No
Frequency extender compatible	No
Frequency range	100 kHz to 9.0 GHz
Full frequency accuracy	$\pm 2 \cdot 10^{-6}$
Frequency resolution	1 Hz
Number of measurement points	2 to 500,001
Measurement bandwidths (with 1/1.5/2/3/5/7 steps)	1 Hz to 2 MHz
Dynamic range <sup>2</sup>	
100 kHz to 1 MHz	105 dB
1 MHz to 8 GHz	148 dB (152 dB typ.)
8 GHz to 9 GHz	138 dB (142 dB typ.)

## Uncorrected System Performance

<b>100 kHz to 1 MHz</b>	
Directivity	12 dB
Source match	12 dB
Load match	12 dB
<b>1 MHz to 9 GHz</b>	
Directivity	18 dB
Source match	20 dB
Load match	20 dB

## Block Diagram of Cobalt C1209

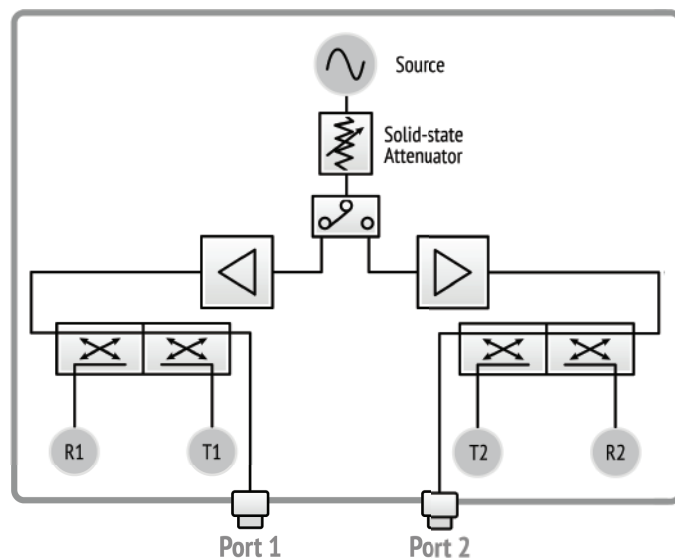

## Test Port Input

<b>Noise floor</b>	
100 kHz to 1 MHz	-100 dBm/Hz
1 MHz to 8 GHz	-143 dBm/Hz
8 GHz to 9 GHz	-133 dBm/Hz
<b>Damage level</b>	+26 dBm
<b>Damage DC voltage</b>	35 V

## System & Power

<b>Operating system</b>	Windows 7 and above
<b>CPU frequency</b>	1.5 GHz
<b>RAM</b>	1 GB
<b>Interface</b>	USB 2.0
<b>Connector type</b>	USB B
<b>Power supply</b>	110-240 V, 50/60 Hz
<b>Power consumption</b>	40W

## Dimensions

<b>Length</b>	425 mm
<b>Width</b>	235 mm
<b>Height</b>	96 mm
<b>Weight</b>	5.5 kg (194 oz)

[1] All specifications subject to change without notice. [2] The dynamic range is defined as the difference between the specified maximum power level and the specified noise floor. The specification applies at 10 Hz IF bandwidth. © Copper Mountain Technologies – [www.coppermountaintech.com](http://www.coppermountaintech.com) | Rev. 2020Q3

# C2209 Specifications<sup>1</sup>

## Primary Specifications

Impedance	50 Ohm
Test port connector	type N, female
Number of test ports	2 ports
Direct Access (Source, Ref, and Meas)	Yes
Frequency extender compatible	No
Frequency range	100 kHz to 9.0 GHz
Full frequency accuracy	$\pm 2 \cdot 10^{-6}$
Frequency resolution	1 Hz
Number of measurement points	2 to 500,001
Measurement bandwidths (with 1/1.5/2/3/5/7 steps)	1 Hz to 2 MHz
Dynamic range <sup>2</sup>	
100 kHz to 1 MHz	105 dB
1 MHz to 8 GHz	148 dB (152 dB typ.)
8 GHz to 9 GHz	138 dB (142 dB typ.)

## Uncorrected System Performance

100 kHz to 1 MHz	
Directivity	12 dB
Source match	12 dB
Load match	12 dB
1 MHz to 9 GHz	
Directivity	15 dB
Source match	15 dB
Load match	15 dB

## Block Diagram of Cobalt C2209

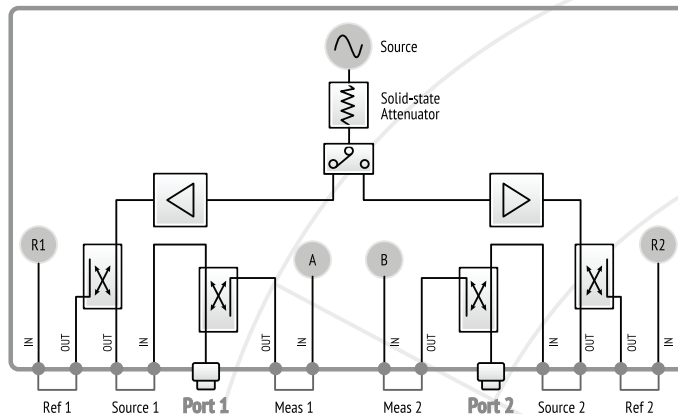

## Test Port Input

Noise floor	
100 kHz to 1 MHz	-100 dBm/Hz
1 MHz to 8 GHz	-143 dBm/Hz
8 GHz to 9 GHz	-133 dBm/Hz
Damage level	+26 dBm
Damage DC voltage	35 V
Direct receiver access ports	Yes
Maximum operating input power level	
Ref	-3 dBm
Source	15 dBm
Meas	-3 dBm
Damage level	
Ref	13 dBm
Source	26 dBm
Meas	13 dBm
Damage DC voltage	
Ref	0 V
Source	35 V
Meas	0 V

## System & Power

Operating system	Windows 7 and above
CPU frequency	1.5 GHz
RAM	1 GB
Interface	USB 2.0
Connector type	USB B
Power supply	110-240 V, 50/60 Hz
Power consumption	40 W

## Dimensions

Length	355 mm
Width	440 mm
Height	96 mm
Weight	7 kg (247 oz)

[1] All specifications subject to change without notice. [2] The dynamic range is defined as the difference between the specified maximum power level and the specified noise floor. The specification applies at 10 Hz IF bandwidth. © Copper Mountain Technologies – www.coppermountaintech.com | Rev. 2020Q3

# C4209 Specifications<sup>1</sup>

## Primary Specifications

Impedance	50 Ohm
Test port connector	type N, female
Number of test ports	2 ports
Direct Access (Source, Ref, and Meas)	No
Frequency extender compatible	Yes
Frequency range*	100 kHz to 9.0 GHz
Full frequency accuracy	$\pm 2 \cdot 10^{-6}$
Frequency resolution	1 Hz
Number of measurement points	2 to 500,001
Measurement bandwidths (with 1/1.5/2/3/5/7 steps)	1 Hz to 2 MHz
Dynamic range <sup>2</sup>	
100 kHz to 1 MHz	105 dB
1 MHz to 8 GHz	148 dB (152 dB typ.)
8 GHz to 9 GHz	138 dB (142 dB typ.)

## System & Power

Operating system	Windows 7 and above
CPU frequency	1.5 GHz
RAM	1 GB
Interface	USB 2.0
Connector type	USB B
Power supply	110-240 V, 50/60 Hz
Power consumption	75 W

## Dimensions

Length	355 mm
Width	440 mm
Height	96 mm
Weight	7 kg (247 oz)

## Uncorrected System Performance

<b>100 kHz to 1 MHz</b>	
Directivity	12 dB
Source match	12 dB
Load match	12 dB
<b>1 MHz to 9 GHz</b>	
Directivity	18 dB
Source match	20 dB
Load match	20 dB

## Test Port Input

<b>Noise floor</b>	
100 kHz to 1 MHz	-100 dBm/Hz
1 MHz to 8 GHz	-143 dBm/Hz
8 GHz to 9 GHz	-133 dBm/Hz
<b>Damage level</b>	+26 dBm
<b>Damage DC voltage</b>	35 V

## Block Diagram of Cobalt C4209

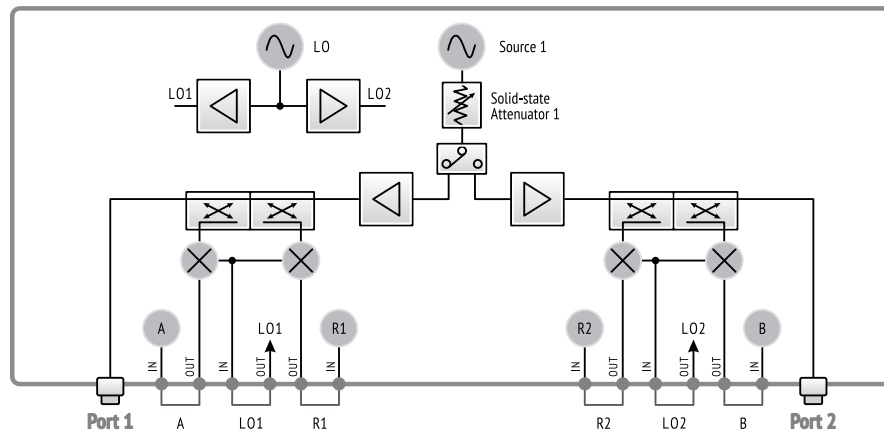

[1] All specifications subject to change without notice. [\*] Upper frequency limit is equal 9.6 GHz. All specifications in the frequency range from 9 GHz to 9.6 GHz are typical. [2] The dynamic range is defined as the difference between the specified maximum power level and the specified noise floor. The specification applies at 10 Hz IF bandwidth. © Copper Mountain Technologies – [www.coppermountaintech.com](http://www.coppermountaintech.com) | Rev. 2020Q3



# C1409 Specifications<sup>1</sup>

## Primary Specifications

Impedance	50 Ohm
Test port connector	type N, female
Number of test ports	4 ports
Direct Access (Source, Ref, and Meas)	No
Frequency extender compatible	No
Frequency range	100 kHz to 9.0 GHz
Full frequency accuracy	$\pm 2 \cdot 10^{-6}$
Frequency resolution	1 Hz
Number of measurement points	2 to 500,001
Measurement bandwidths (with 1/1.5/2/3/5/7 steps)	1 Hz to 2 MHz
Dynamic range <sup>2</sup>	
100 kHz to 1 MHz	105 dB
1 MHz to 8 GHz	148 dB (152 dB typ.)
8 GHz to 9 GHz	138 dB (142 dB typ.)

## Uncorrected System Performance

<b>100 kHz to 1 MHz</b>	
Directivity	12 dB
Source match	12 dB
Load match	12 dB
<b>1 MHz to 9 GHz</b>	
Directivity	18 dB
Source match	20 dB
Load match	20 dB

## Test Port Input

<b>Noise floor</b>	
100 kHz to 1 MHz	-100 dBm/Hz
1 MHz to 8 GHz	-143 dBm/Hz
8 GHz to 9 GHz	-133 dBm/Hz
<b>Damage level</b>	+26 dBm
<b>Damage DC voltage</b>	35 V

## System & Power

<b>Operating system</b>	Windows 7 and above
<b>CPU frequency</b>	1.5 GHz
<b>RAM</b>	1 GB
<b>Interface</b>	USB 2.0
<b>Connector type</b>	USB B
<b>Power supply</b>	110-240 V, 50/60 Hz
<b>Power consumption</b>	75W

## Dimensions

<b>Length</b>	355 mm
<b>Width</b>	440 mm
<b>Height</b>	96 mm
<b>Weight</b>	10 kg (353 oz)

## Block Diagram of Cobalt C1409

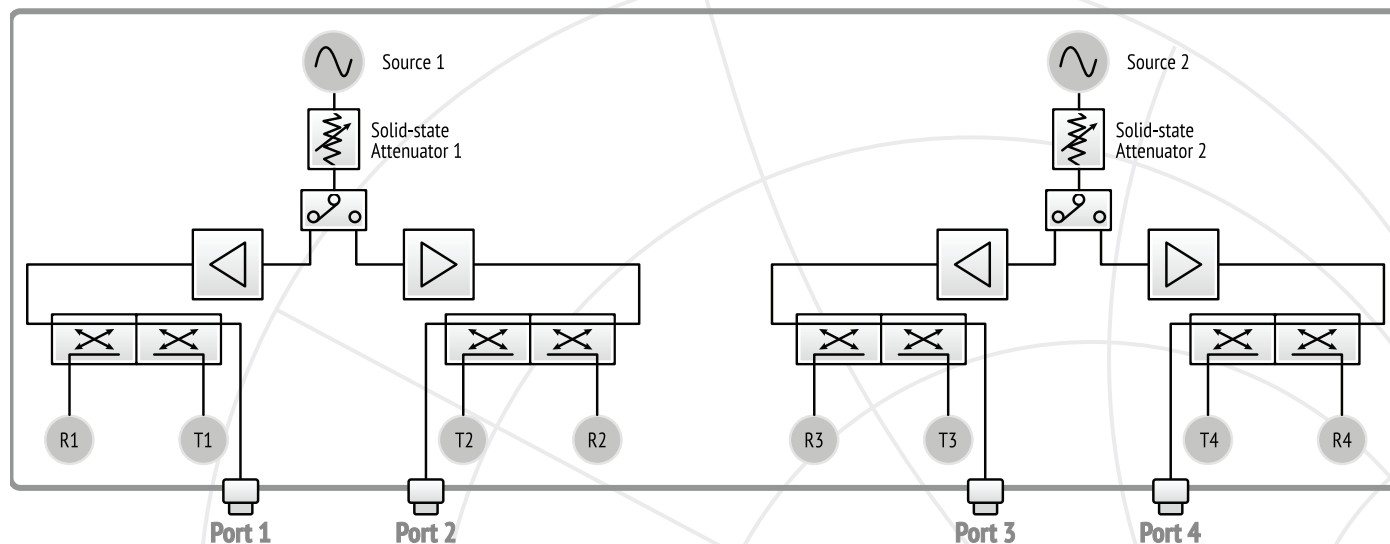

[1] All specifications subject to change without notice. [2] The dynamic range is defined as the difference between the specified maximum power level and the specified noise floor. The specification applies at 10 Hz IF bandwidth. © Copper Mountain Technologies – [www.coppermountaintech.com](http://www.coppermountaintech.com) | Rev.2020Q3

# C2409 Specifications<sup>1</sup>

## Primary Specifications

Impedance	50 Ohm
Test port connector	type N, female
Number of test ports	4 ports
Direct Access (Source, Ref, and Meas)	Yes
Frequency extender compatible	No
Frequency range	100 kHz to 9.0 GHz
Full frequency accuracy	$\pm 2 \cdot 10^{-6}$
Frequency resolution	1 Hz
Number of measurement points	2 to 500,001
Measurement bandwidths (with 1/1.5/2/3/5/7 steps)	1 Hz to 2 MHz
Dynamic range <sup>2</sup>	
100 kHz to 1 MHz	105 dB
1 MHz to 8 GHz	148 dB (152 dB typ.)
8 GHz to 9 GHz	138 dB (142 dB typ.)

## Uncorrected System Performance

100 kHz to 1 MHz	
Directivity	12 dB
Source match	12 dB
Load match	12 dB
1 MHz to 9 GHz	
Directivity	15 dB
Source match	15 dB
Load match	15 dB

## Test Port Input

Noise floor	
100 kHz to 1 MHz	-100 dBm/Hz
1 MHz to 8 GHz	-143 dBm/Hz
8 GHz to 9 GHz	-133 dBm/Hz
Damage level	
	+26 dBm
Damage DC voltage	
	35 V
Direct receiver access ports	
Maximum operating input power level	
Ref	-3 dBm
Source	15 dBm
Meas	-3 dBm
Damage level	
Ref	13 dBm
Source	26 dBm
Meas	13 dBm
Damage DC voltage	
Ref	0 V
Source	35 V
Meas	0 V

## System & Power

Operating system	Windows 7 and above
CPU frequency	1.5 GHz
RAM	1 GB
Interface	USB 2.0
Connector type	USB B
Power supply	110-240 V, 50/60 Hz
Power consumption	75W

## Dimensions

Length	355 mm
Width	440 mm
Height	96 mm
Weight	10 kg (353 oz)

## Block Diagram of Cobalt C2409

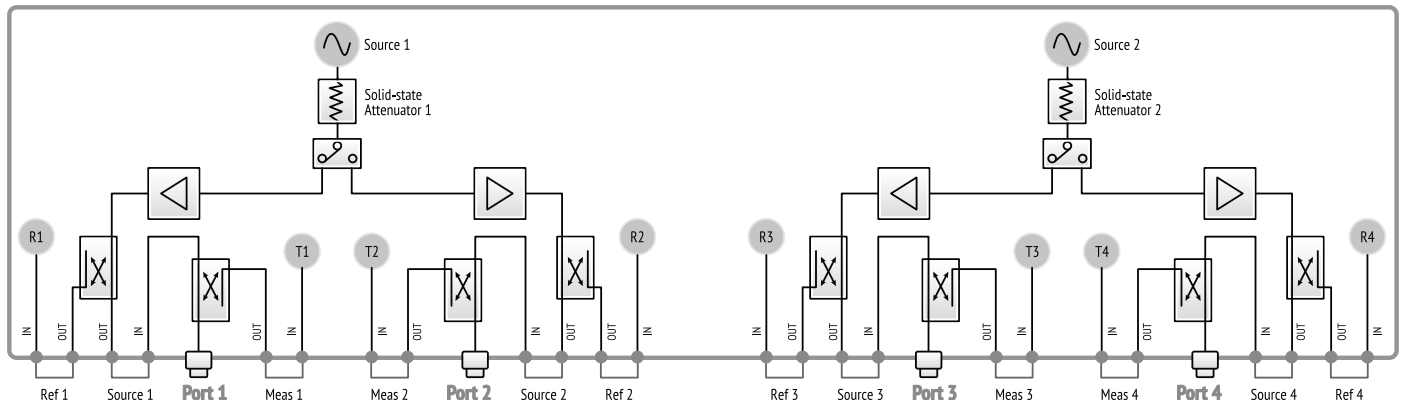

[1] All specifications subject to change without notice. [2] The dynamic range is defined as the difference between the specified maximum power level and the specified noise floor. The specification applies at 10 Hz IF bandwidth. © Copper Mountain Technologies – [www.coppermountaintech.com](http://www.coppermountaintech.com) | Rev. 2020Q3

# C4409 Specifications<sup>1</sup>

## Primary Specifications

Impedance	50 Ohm
Test port connector	type N, female
Number of test ports	4 ports
Direct Access (Source, Ref, and Meas)	No
Frequency extender compatible	Yes
Frequency range*	100 kHz to 9.0 GHz
Full frequency accuracy	$\pm 2 \cdot 10^{-6}$
Frequency resolution	1 Hz
Number of measurement points	2 to 500,001
Measurement bandwidths (with 1/1.5/2/3/5/7 steps)	1 Hz to 2 MHz
Dynamic range <sup>2</sup>	
100 kHz to 1 MHz	105 dB
1 MHz to 8 GHz	148 dB (152 dB typ.)
8 GHz to 9 GHz	138 dB (142 dB typ.)

## Uncorrected System Performance

<b>100 kHz to 1 MHz</b>	
Directivity	12 dB
Source match	12 dB
Load match	12 dB
<b>1 MHz to 9 GHz</b>	
Directivity	18 dB
Source match	20 dB
Load match	20 dB

## Test Port Input

<b>Noise floor</b>	
100 kHz to 1 MHz	-100 dBm/Hz
1 MHz to 8 GHz	-143 dBm/Hz
8 GHz to 9 GHz	-133 dBm/Hz
<b>Damage level</b>	+26 dBm
<b>Damage DC voltage</b>	35 V

## System & Power

<b>Operating system</b>	Windows 7 and above
<b>CPU frequency</b>	1.5 GHz
<b>RAM</b>	1 GB
<b>Interface</b>	USB 2.0
<b>Connector type</b>	USB B
<b>Power supply</b>	110-240 V, 50/60 Hz
<b>Power consumption</b>	145W

## Dimensions

<b>Length</b>	355 mm
<b>Width</b>	440 mm
<b>Height</b>	96 mm
<b>Weight</b>	10 kg (353 oz)

## Block Diagram of Cobalt C4409

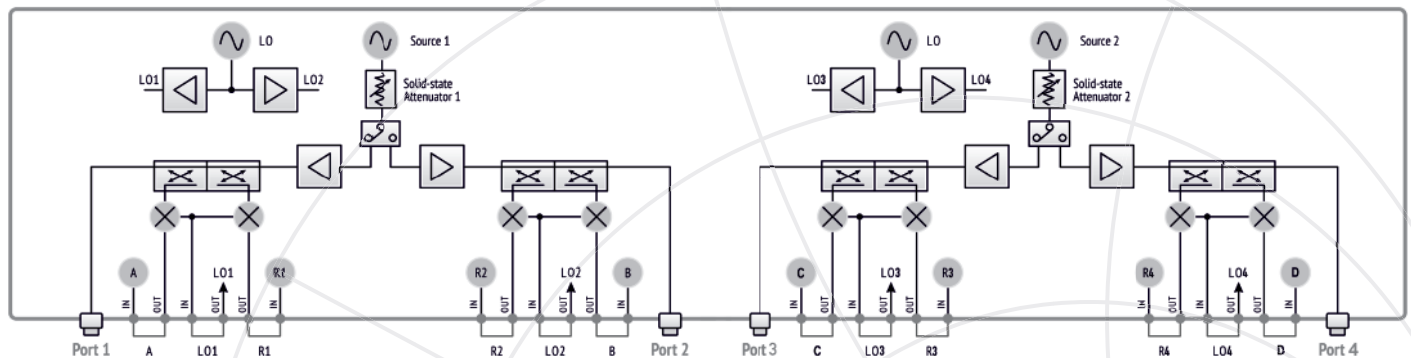

[1] All specifications subject to change without notice. [\*] Upper frequency limit is equal 9.6 GHz. All specifications in the frequency range from 9 GHz to 9.6 GHz are typical. [2] The dynamic range is defined as the difference between the specified maximum power level and the specified noise floor. The specification applies at 10 Hz IF bandwidth. © Copper Mountain Technologies - www.coppermountaintech.com | Rev. 2020Q3



Technology is supposed to move. It's supposed to change and update and progress. It's not meant to sit stagnant year after year simply because that's how things have always been done.

The engineers at Copper Mountain Technologies are creative problem solvers. They know the people using VNAs don't just need one giant machine in a lab. They know that VNAs are needed in the field, requiring portability and flexibility. Data needs to be quickly transferred, and a test setup needs to be easily automated and recalled for various applications. The engineers at Copper Mountain Technologies are rethinking the way VNAs are developed and used.

Copper Mountain Technologies' VNAs are designed to work with the Windows or Linux PC you already use via USB interface. After installing the test software, you have a top-quality VNA at a fraction of the cost of a traditional analyzer. The result is a faster, more effective test process that fits into the modern workspace. This is the creativity that makes Copper Mountain Technologies stand out above the crowd.

 ***We're creative. We're problem solvers.***



## Cobalt Series Overview: 9 GHz

	C1209	C2209	C4209	C1409	C2409	C4409
Frequency Range	100 kHz to 9 GHz	100 kHz to 9 GHz	100 kHz to 9 GHz	100 kHz to 9 GHz	100 kHz to 9 GHz	100 kHz to 9 GHz
Number of Ports	2	2	2	4	4	4
Additional Features		Direct Receiver Access	Frequency Extension		Direct Receiver Access	Frequency Extension

631 E. New York Street  
Indianapolis, IN 46202

United States: +1.317.222.5400  
Latin America: +1.954.706.5920

APAC: +65.63.23.6546  
EMEA: +44 75 03 69 21 13